



Kinedo

TRAYS | ENCLOSURES | CUBICLES | KINEWALL

Rediscover the pleasure of showering.

The bathroom has changed... it is not just an area of functionality, but a room of pleasure and relaxation.

We want to be stylish and original, modern and attractive. None more so than with our bathroom, a place for calm reflection or vibrant invigoration. Designing your bathroom to be specific for your needs and choosing your shower can be tricky, where will it go, what type of door, what type of tray... the list goes on. But whatever space you have and whatever your taste, Kinedo has the answer.

The Kinedo collection of shower trays offers a range of surfaces, colours, sizes and cuttable options for every scenario. From our luxury granite look linear tray through to our moonstone textured tray there is an option designed for you. Our range of enclosures offers pivot, sliding, bi-fold or saloon doors as well as a wide range of walk-in options in a variety of sizes and a choice of different colour profiles. Kinedo self-contained cubicles offers clever assembly of high-quality materials, to create an all-in-one shower cubicle that requires no silicone or tiles and grout meaning they can be easily installed in less than a day. Kinewall offers a fantastic alternative to tiles, with over 70 designs to choose from these lightweight, waterproof wall panels are easy to cut and install and make transforming a bathroom easier than you may think.

Our Kinedo products are designed, manufactured and tested in our production facilities in France and Italy. This means we control the complete process to maintain the highest standards of quality and service. All of our products come with a comprehensive 10-year warranty.

Global credentials. Local service.

Kinedo is proud to be part of the SFA Group, an international group established in 1958, which designs, tests and manufactures its products across the world. Kinedo are known throughout Europe as one of the largest manufacturers of bathroom products. It means that our customers benefit from:

- **Impressive technological and service know-how**
- **A global presence with 28 subsidiaries over 6 continents and exporting to many more countries**
- **More than sixty years of making and distributing world-class bathroom products**
- **Passionate private ownership**

So you know that quality and local service are always close to our heart.

Did you know...?

Our manufacturing plants produce over **100,000** shower trays and nearly **200,000** shower enclosures and cubicles every year. **And it's growing all the time.**

Our **four Kinedo sites** cover over **53,000m²** of production space and as well as our own research and development facilities, we have in-house test laboratories where we carry out over **50 different quality tests** on our products.



Aqua production in Chaumes-en-Retz – 30,00m² across 2 sites



Setma production in La Ciotat – 16,000m² across 3 sites

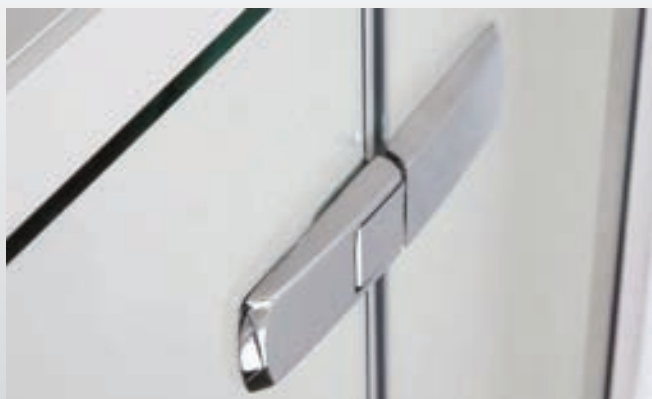

We also ensure that all our glass panels and doors meet the **European standard EN12150** for **toughened safety glass** and we supply our products flat-packed for ease of manoeuvrability.



Kinedo products have a **10 year warranty**, **2 years as standard and 8 years on parts**. For full details please see the Kinedo website: kinedo.co.uk



The art of style. **The science of quality.**

Our innovation philosophy is straightforward. Shower product that looks great, lasts for ages, saves time on installation and requires low or zero maintenance.

Investing millions each year in R&D, we bring together experienced Kinedo engineers with innovative designers from all over the world – injecting fresh ideas into both design and production. And with over 50 different quality tests on every product, you have the ultimate reassurance of quality.

The perfect fit. The right size and style, to suit your build and budget.

Whatever your project, Kinedo will help you discover the perfect solution – with a huge array of products to suit all styles and spaces. But more than that, we enjoy working with you, hearing your ideas so we can find new, bespoke ways to help your bathroom stand apart.

Kinedo shower solutions offer:

- National availability of products, stocked items fulfilled from our UK warehouse
- A comprehensive range of showering products for all market levels
- On-site product and installation training for projects
- Our own dedicated in-house technical team to answer questions and give advice
- Local ASM support and account management
- Peace of mind for readily available replacement parts and spares
- Value-for-money pricing

UK service and technical expertise

Our entire customer service team is based in the UK. This means you receive knowledgeable Support from local experts who understand your needs and concerns.

Exceptional After-Sales Support: At Kinedo, we pride ourselves on delivering outstanding after-sales support to ensure your complete satisfaction.

Quick Response Time: Our dedicated customer service team answers your calls in an average of just four seconds. We understand your time is valuable and are here to assist you promptly.

Multichannel Support: Whether you prefer to contact us via phone, email, or website, our friendly and professional team is ready to help. We're committed to resolving your queries efficiently and effectively.

Top-Rated Service: Our commitment to excellence has earned us top ratings in customer satisfaction. We continuously strive to exceed your expectations and deliver the highest quality service.

- **98% First Call Resolution:** We resolve 98% of issues on the first call, ensuring you get the help you need without unnecessary delays.
- **Customer Satisfaction Rating:** We maintain a 95% customer satisfaction rating, reflecting our commitment to delivering exceptional service.

Personalised Aftercare: We don't just solve your problems; we follow up to ensure everything is perfect. Our personalised aftercare service guarantees that you are delighted with our solutions.

Authentic manufacturer spare parts

Genuine Parts Guaranteed: We provide only authentic manufacturer spare parts, ensuring the highest quality and compatibility with your products. This guarantees optimal performance and longevity.

Extensive Inventory: Our vast inventory of genuine spare parts means we can quickly supply the parts you need, minimising downtime and maintaining the efficiency of your products.

Trust and Reliability: With years of experience and a proven track record, you can trust Kinedo to provide reliable and effective after-sales support.

Experience the difference with Kinedo's top-tier after-sales service. We're here to support you every step of the way.



Kinedo – Committed to CSR

Reuse and recycle

The SFA Group are dedicated to Corporate Social Responsibility and from 2016 have pushed forward with a campaign not only to adhere to regulatory compliance but also to deliver on our plans to make changes within our group for the environment. We looked at all of our factories and offices to make changes to our daily practices to deliver our ambitious CSR plans and respond to challenges in Communication, HR and across the business as a whole.

Looking at our Aqua Production site in Nantes here are some of the actions we have taken:



Glass

An infinitely recyclable material. As a major element of our enclosure and cubicle manufacturing process, we optimise cutting and any scraps are sent to a recycling centre.



Water

We monitor and control the water consumption used in our processes, for example the water used in the process of glass machining (drilling and shaping) is reused several times, it is then purified. We ensure there is no polluted water discharged from the factory.



Aluminium

We use this raw material in the manufacture of our enclosures, cubicles and bath screens. We optimise cutting to reduce scraps and these are then sent to a recycling centre.



Energy

We are constantly looking at ways to reduce our energy consumption. From optimising processes, reducing waste, and using low consumption electrical equipment to name a few, this allows us to reduce our energy consumption per product manufactured. Another project we have completed is to ensure all our buildings have solar panels to help our energy consumption.

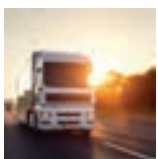

Logistics

We carefully choose our logistic partners based partly on their CSR commitments. We have a current project in place to gradually replace our service vehicles with electric vehicles.



Plastic

Plastic is used in the manufacture of some of our trays, any scraps are sent to a recycling centre. Our design team has an Eco-design approach and has already incorporated ceramic beads into our manufacturing processes in order to limit the use of resins and polyurethane.



Packaging

Our packaging is designed to protect our products and needs to be robust to prevent breakages during transportation. We limit the weight of packaging to reduce our carbon footprint. We are working in partnership with our packaging suppliers to increase the use of recycled materials.



Waste

We are constantly looking at ways to improve our organisation in order to limit the production of waste. We have a recycling policy and work with a service provider to recycle as much as possible.

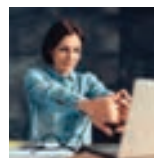

Social

Improving working conditions plays a huge part in our plans. With numerous investments in robots and technologies to make work life easier. Stretching exercises are encouraged during the work day to help provide comfort for our teams in both the production plants and in offices.



Since 2021, SFA has committed to the United Nations Global Compact **corporate responsibility initiative and its principles** regarding human rights, labour, environment, and anti-corruption efforts.



Contents

Trays	08	En-suite	120
KINEMOON	10 - 13	MODULO	122 - 125
KINEROCK EVO	14 - 17	MODULO XL	126 - 129
KINELINE	18 - 21		
Enclosures	22	Shower/bath	130
WALK-IN	24 - 57	KINEDUO	132 - 135
KINESTYLE	58 - 67		
SMART DESIGN	68 - 85	Kinewall	136
Cubicles	86	MIXED DESIGNS	142 - 145
BROOKLYN	88 - 91	MINERALS & METALS	146 - 149
EDEN	92 - 95	NATURE	150 - 153
HORIZON	96 - 99	PATTERNS & GEOMETRIC	154 - 157
MOONLIGHT	100 - 101	WOOD	158 - 161
KINEPRIME GLASS	102 - 105	KINEWALL ACCESSORIES	163
KINEPRIME CONTRACT	106 - 107	INSTALLATION	164 - 165
CONSORT	108 - 109		
BREHAT FAST	110 - 111		
KINEMAGIC DESIGN	112 - 115		
KINEMAGIC SERENITY	116 - 119		

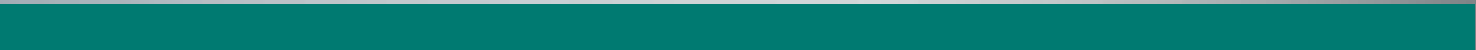

Trays

CONTENTS

KINEMOON	10 - 13
KINEROCK EVO	14 - 17
KINELINE	18 - 21



Cuttable

Our trays can be cut to allow you to create the perfect showering space. From uneven walls, to boxed pipework our cuttable trays are fit for anywhere.



Colours

We offer a range of colours to suit your bathroom, from white, black, grey, sable and anthracite there are several options for your shower tray.



Material

Our tray ranges are made from Biolex. An innovative material, Biolex is a mineral composite. It is made up of mineral (80%), acrylic resin and gel coat surface. This unique finish not only looks good but is also robust and resistant to damage.



Anti-slip

All our trays are PN24** rated so are safe for the whole family.

** PN24 is an equivalent test to DIN 51097 C

Kinemoon

The Kinemoon creates an out of this world showering experience. The textured tray is available in five colours and has a matching waste cover, helping you to create your perfect style whichever colour tray you choose.

- Available in 5 colours
- Finish: Moonstone look and texture
- Thickness: 26mm
- Shape: square and rectangle
- Colour co-ordinated square waste cover, central to the tray (24l/m)
- Made from Biolex, a mineral composite. It is made up of mineral (80%), acrylic resin and gel coat surface. This unique finish not only looks good but is also robust and resistant to damage
- Cuttable on four sides
- Versatile: can be placed on the floor, raised on feet or sunk into the floor for a flat wet room look
- Tray comes complete with:
 - Extra-flat waste
 - Metal waste cover to match your chosen tray colour
- Tested to PN24. Equivalent test to DIN 51097 C



Kinemoon 1800 x 800 – white

Colours



White Anthracite Grey Black Sable

Fit your space

	900	1000	1200	1400	1600	1700	1800
700		■	■	■		■	
750	■						
800		■	■	■	■		■
900	■	■	■	■	■		■

■ Square ■ Rectangle

All measurements in mm

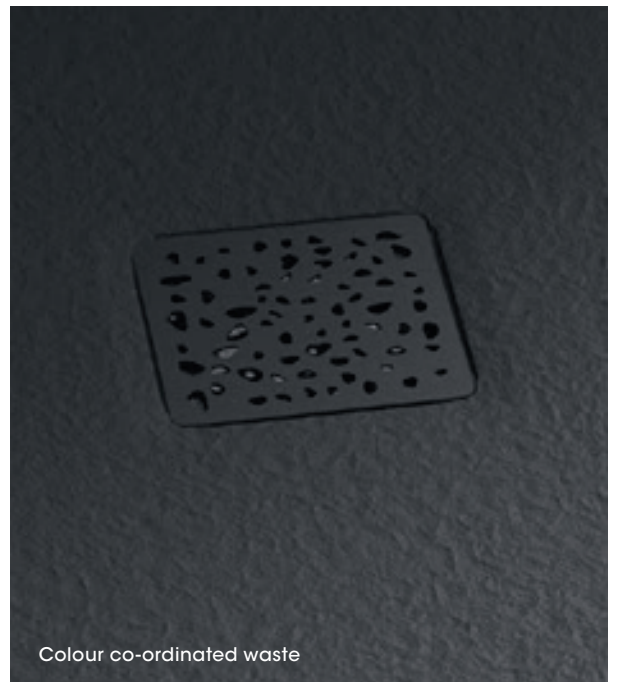

Colour co-ordinated waste

Features



10 year warranty



Easy maintenance



5 colours



Ease of installation



Textured finish



Colour co-ordinated waste cover



Cuttable



Anti-slip



26mm thick

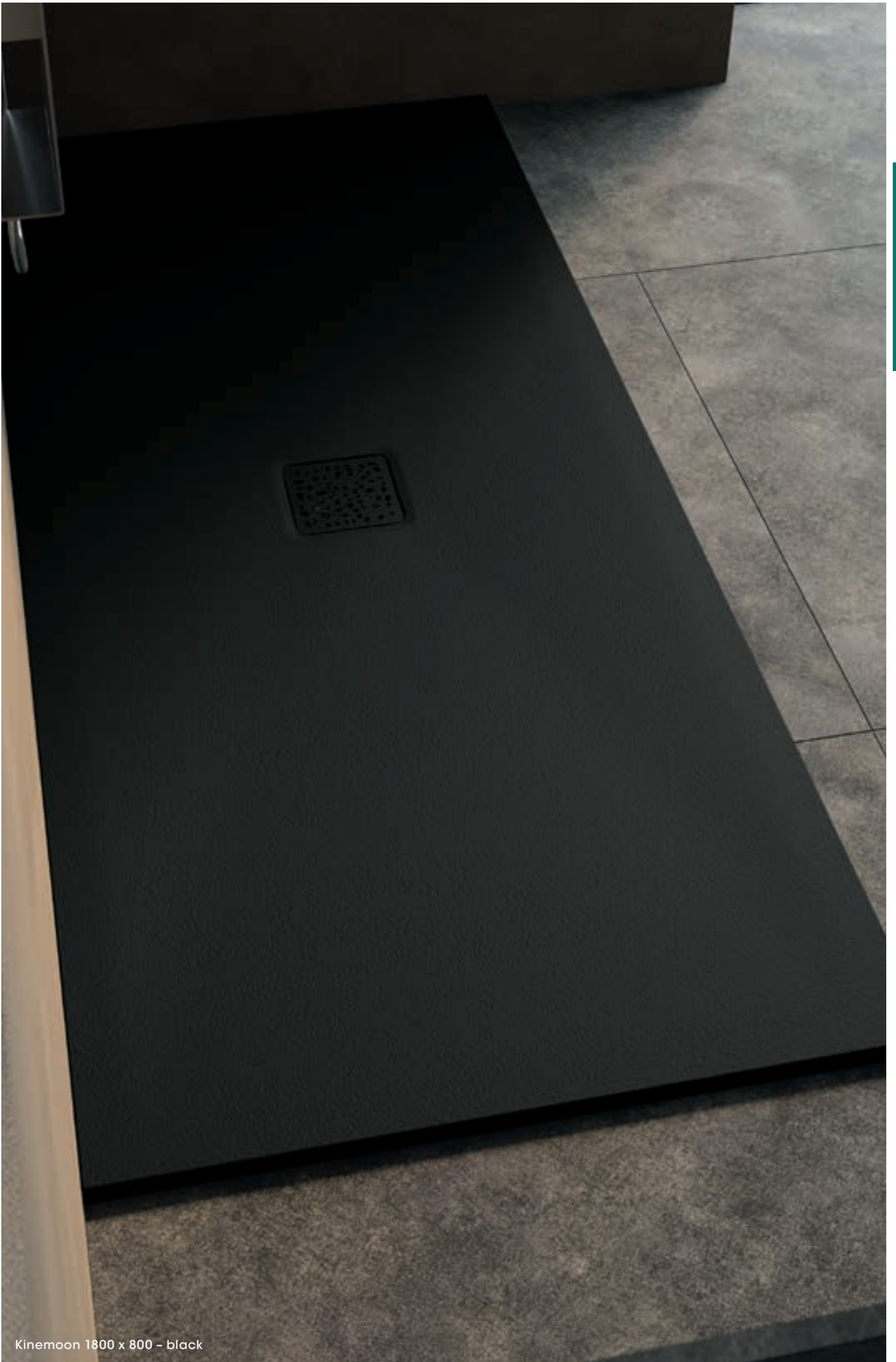

Kinemoon 1800 x 800 - black

Product codes and dimensions

Size	Product codes						See dimensions on next page				
	White	Anthracite	Black	Grey	Sable	Feet	X	Y	B	C	D
900 x 750	RD1300	RD1300A	RD1300N	RD1300P	RD1300S	KINPIED09	900	750	385	250	325
900 x 900	RD1301	RD1301A	RD1301N	RD1301P	RD1301S	KINPIED09	900	900	385	325	325
1000 x 700	RD1302	RD1302A	RD1302N	RD1302P	RD1302S	KINPIED09	1000	700	435	225	375
1000 x 800	RD1303	RD1303A	RD1303N	RD1303P	RD1303S	KINPIED09	1000	800	435	275	375
1000 x 900	RD1304	RD1304A	RD1304N	RD1304P	RD1304S	KINPIED09	1000	900	435	325	375
1200 x 700	RD1305	RD1305A	RD1305N	RD1305P	RD1305S	KINPIED11	1200	700	535	225	475
1200 x 800	RD1306	RD1306A	RD1306N	RD1306P	RD1306S	KINPIED11	1200	800	535	275	475
1200 x 900	RD1307	RD1307A	RD1307N	RD1307P	RD1307S	KINPIED11	1200	900	535	325	475
1400 x 700	RD1308	RD1308A	RD1308N	RD1308P	RD1308S	KINPIED03	1400	700	635	225	575
1400 x 800	RD1309	RD1309A	RD1309N	RD1309P	RD1309S	KINPIED03	1400	800	635	275	575
1400 x 900	RD1310	RD1310A	RD1310N	RD1310P	RD1310S	KINPIED03	1400	900	635	325	575
1600 x 800	RD1311	RD1311A	RD1311N	RD1311P	RD1311S	KINPIED03	1600	800	735	275	675
1600 x 900	RD1312	RD1312A	RD1312N	RD1312P	RD1312S	KINPIED03	1600	900	735	325	675
1700 x 700	RD1313	RD1313A	RD1313N	RD1313P	RD1313S	KINPIED03	1700	700	785	225	725
1800 x 800	RD1314	RD1314A	RD1314N	RD1314P	RD1314S	KINPIED12	1800	800	835	275	775
1800 x 900	RD1315	RD1315A	RD1315N	RD1315P	RD1315S	KINPIED12	1800	900	835	325	775



Recommended feet for raised installation

	Code
Kinemoon feet for 900 and 1000mm trays (5 feet)	KINPIED09
Kinemoon feet for 1200mm trays (8 feet)	KINPIED11
Kinemoon feet for 1400, 1600 and 1700mm trays (10 feet)	KINPIED03
Kinemoon feet for 1800mm trays (12 feet)	KINPIED12



Kinemoon 1200 x 900 – white



Kinemoon 1200 x 900 – anthracite

Dimensions

See table for measurements

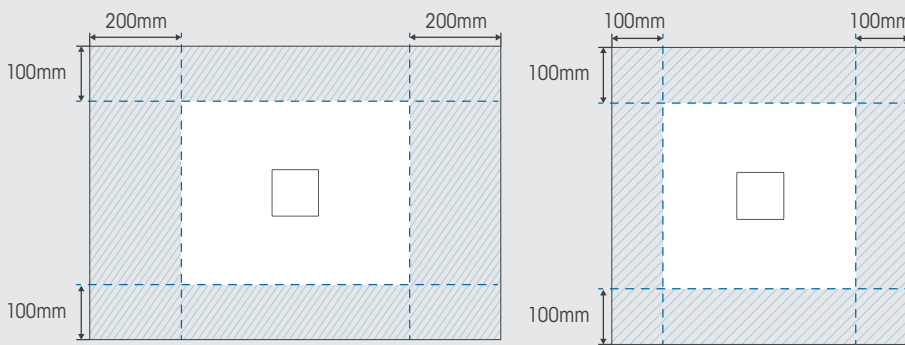
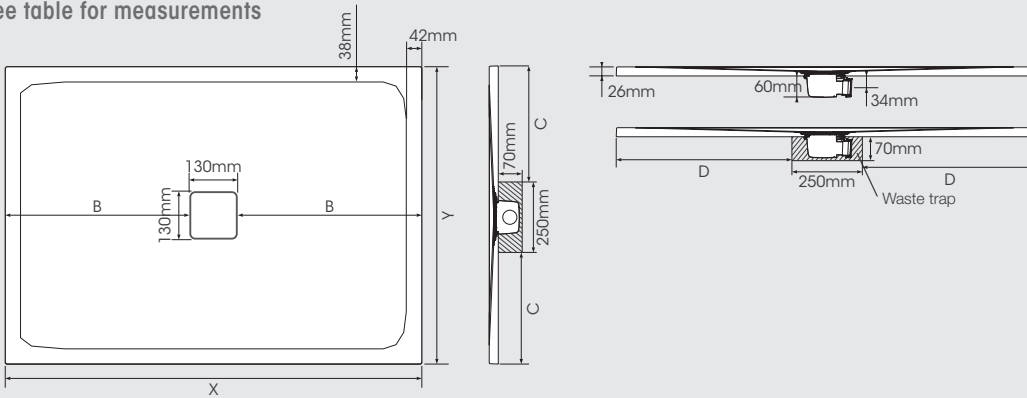

Maximum cutting area
(If the tray is not fully recessed, the cut dimensions must be positioned against the walls)

All measurements in mm



Kinemoon 1200 x 900 – grey



Kinemoon 1200 x 900 – sable

Kinerock Evo

The Kinerock Evo shower tray brings a natural mineral texture to your bathroom, bringing the outside, in. Creating your perfect showering experience is easy with this natural looking tray which creates a spa type look and feel.

- Available in 5 colours for popular sizes
- Finish: Mineral texture
- Thickness: 30mm
- Shape: square, rectangle and quadrant
- Colour co-ordinated rectangular waste cover, towards one end of the tray, middle of the corner for quadrant (24l/m)
- Made from Biolex, a mineral composite. It is made up of mineral (80%), acrylic resin and gel coat surface. This unique finish not only looks good but is also robust and resistant to damage
- Cuttable on four sides (quadrant cuttable on 2 sides)
- Versatile: can be placed on the floor, raised on feet or sunk into the floor for a flat wet room look
- Tray comes complete with:
 - Extra-flat waste
 - Metal waste cover to match your chosen tray colour
- Tested to PN24. Equivalent test to DIN 51097 C

Colours



White



Anthracite



Grey



Black



Sable



Colour co-ordinated waste

Fit your space

	700	800	900	1000
800		■		
900	■		■ ▽	
1000	■	■	■	■
1200	■	■	■	■
1400	■	■	■	■
1500	■	■	■	
1600	■	■	■	■
1700	■	■	■	
1800		■	■	■
2000		■	■	■

■ Square ▽ Quadrant ■ Rectangle

All measurements in mm



Kinerock Evo 900 x 900 – black

Features



10 year warranty



Easy maintenance



5 colours



Ease of installation



Textured finish



Colour co-ordinated waste cover

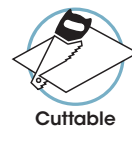

Cuttable



Anti-slip



30mm thick



Kinerock Evo 1800 x 900 - sable

Product codes and dimensions

Size	Product codes						See dimensions on next page								
	White	Anthracite	Black	Grey	Sable	Feet	A	B	C	D	E	F	G	X	Y
800 x 800	RD9002	RD9002A	RD9002N	RD9002P	RD9002S	KINPIED09	335	335	275	275	275	30	30	800	800
900 x 700	RD9006	-	-	-	-	KINPIED09	255	515	225	195	455	30	40	900	700
900 x 900	RD9003	RD9003A	RD9003N	RD9003P	RD9003S	KINPIED09	385	385	325	325	325	30	30	900	900
900 x 900 Quad	RD9005	-	-	-	-	KINPIED11	300	350	-	155	495	80	40	900	900
1000 x 700	RD9007	-	-	-	-	KINPIED09	255	615	225	195	555	30	40	1000	700
1000 x 800	RD9008	RD9008A	RD9008N	RD9008P	RD9008S	KINPIED09	305	565	275	245	505	30	35	1000	800
1000 x 900	RD9009	RD9009A	RD9009N	RD9009P	RD9009S	KINPIED09	355	515	325	295	455	30	35	1000	900
1000 x 1000	RD9010	RD9010A	RD9010N	RD9010P	RD9010S	KINPIED11	435	435	375	375	375	30	30	1000	1000
1200 x 700	RD9013	-	-	-	-	KINPIED11	305	755	225	245	705	30	45	1200	700
1200 x 800	RD9014	RD9014A	RD9014N	RD9014P	RD9014S	KINPIED11	305	765	275	245	705	30	45	1200	800
1200 x 900	RD9015	RD9015A	RD9015N	RD9015P	RD9015S	KINPIED11	355	715	325	295	655	30	40	1200	900
1200 x 1000	RD9016	RD9016A	RD9016N	RD9016P	RD9016S	KINPIED11	355	715	375	295	655	30	40	1200	1000
1400 x 700	RD9019	-	-	-	-	KINPIED11	255	1015	225	195	955	25	40	1400	700
1400 x 800	RD9020	RD9020A	RD9020N	RD9020P	RD9020S	KINPIED03	305	965	275	245	905	30	40	1400	800
1400 x 900	RD9021	RD9021A	RD9021N	RD9021P	RD9021S	KINPIED03	355	915	325	295	855	30	40	1400	900
1400 x 1000	RD9022	RD9022A	RD9022N	RD9022P	RD9022S	KINPIED03	355	915	375	295	855	30	40	1400	1000
1500 x 700	RD9023	-	-	-	-	KINPIED11	255	1115	225	195	1055	30	40	1500	700
1500 x 800	RD9024	-	-	-	-	KINPIED03	305	1065	275	245	1005	30	40	1500	800
1500 x 900	RD9025	-	-	-	-	KINPIED03	355	1015	325	295	955	30	45	1500	900
1600 x 700	RD9026	-	-	-	-	KINPIED03	255	1215	225	195	1155	30	140	1600	700
1600 x 800	RD9027	RD9027A	RD9027N	RD9027P	RD9027S	KINPIED03	305	1165	275	245	1105	30	40	1600	800
1600 x 900	RD9028	RD9028A	RD9028N	RD9028P	RD9028S	KINPIED03	355	1115	325	295	1055	30	40	1600	900
1600 x 1000	RD9029	RD9029A	RD9029N	RD9029P	RD9029S	KINPIED03	355	1115	375	295	1055	30	40	1600	1000
1700 x 700	RD9030	-	-	-	-	KINPIED03	255	1315	225	195	1255	30	40	1700	700
1700 x 800	RD9031	-	-	-	-	KINPIED03	305	1265	275	245	1205	30	240	1700	800
1700 x 900	RD9032	-	-	-	-	KINPIED03	305	1265	325	245	1205	130	45	1700	900
1800 x 800	RD9033	RD9033A	RD9033N	RD9033P	RD9033S	KINPIED03	305	1365	275	245	1305	30	40	1800	800
1800 x 900	RD9034	RD9034A	RD9034N	RD9034P	RD9034S	KINPIED03	355	1315	325	295	1255	30	40	1800	900
1800 x 1000	RD9035	RD9035A	RD9035N	RD9035P	RD9035S	KINPIED03	355	1315	375	295	1255	30	40	1800	1000
2000 x 800	RD9038	-	-	-	-	KINPIED04	305	1565	275	245	1505	35	45	2000	800
2000 x 900	RD9039	-	-	-	-	KINPIED04	305	1565	325	245	1505	35	45	2000	900
2000 x 1000	RD9037	-	-	-	-	KINPIED04	305	1565	375	245	1505	35	45	2000	1000





Recommended feet for raised installation

	Code
Kinerock Evo feet for 700-1000mm trays (5 feet)	KINPIED09
Kinerock Evo feet for 1000-1500mm trays (8 feet)	KINPIED11
Kinerock Evo feet for 1400-1800mm trays (10 feet)	KINPIED03
Kinerock Evo feet for 1900-2000mm trays (12 feet)	KINPIED12
Kinerock Evo feet (16 feet)	KINPIED04

Dimensions

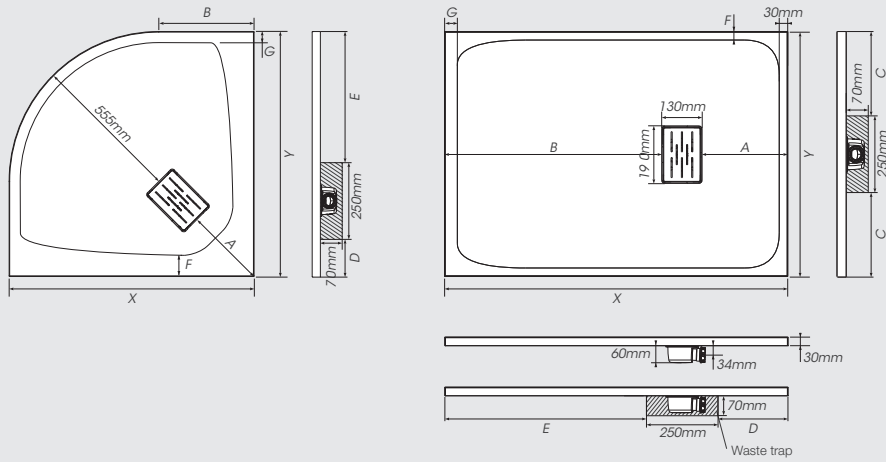
See table for measurements



 **Maximum cutting area**
 (If the tray is not fully recessed, the cut dimensions must be positioned against the walls)

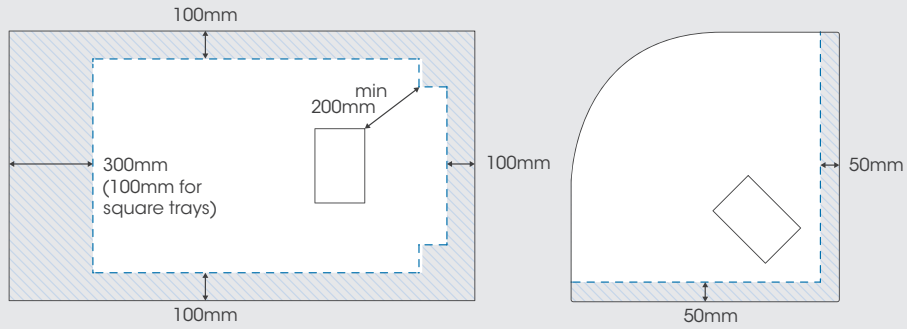

All measurements in mm



Kinerock Evo 900 x 900 quadrant - white



Kinerock Evo 1200 x 900 - grey

Kineline

The Kineline tray brings sleek elegance to your shower. This tray with a linear waste, has a granite look and feel and whichever colour or installation option you choose, this designer tray will help create your dream bathroom.

- Available in 5 colours
- 5 colours available for waste on the short side, white only for waste on the long side
- Finish: Granite look and texture
- Thickness: 26mm for the long side waste and 30mm for the short side waste
- Shape: square and rectangle
- Colour co-ordinated linear waste cover, on the side/top of the tray (24l/m)
- Made from Biolex, a mineral composite. It is made up of mineral (80%), acrylic resin and gel coat surface. This unique finish not only looks good but is also robust and resistant to damage
- Cuttable on three sides
- Versatile: can be placed on the floor, raised on feet or sunk into the floor for a flat wet room look
- Tray comes complete with:
 - Extra-flat waste
 - Waste cover to match your chosen tray colour
- Tested to PN24. Equivalent test to DIN 51097 C

Colours



Fit your space

	800	900	1000	1200	1400	1600	1800
800					Rectangle	Rectangle	Rectangle
800	Square		Rectangle	Rectangle	Rectangle	Rectangle	Rectangle
900					Rectangle	Rectangle	Rectangle
900		Square	Rectangle	Rectangle	Rectangle	Rectangle	Rectangle

Square
 Rectangle
 Waste long side
 Waste short side

All measurements in mm



Features

- 10 year warranty
- Easy maintenance
- 5 colours
- Ease of installation
- Textured finish
- Colour co-ordinated waste cover
- Cuttable
- Anti-slip PN24
- 26mm/30mm depending on waste chosen



Why not add Kinewall
bathroom wall panels to
Kinline
see page 136 for details

Kinline 900 x 900 - anthracite

Product codes and dimensions

Square trays

Size	Product codes						See dimensions on next page				
	White	Anthracite	Black	Grey	Sable	Feet	B	C	D	X	Y
800 x 800	RD320	RD320A	RD320N	RD320P	RD320S	KINPIED09	220	680	215	800	800
900 x 900	RD321	RD321A	RD321N	RD321P	RD321S	KINPIED09	270	780	265	900	900

Rectangular trays with the waste on the short side of the tray

Size	Product codes						See dimensions on next page					
	White	Anthracite	Black	Grey	Sable	Feet	B	C	D	E	X	Y
1000 x 800	RD2000	RD2000A	RD2000N	RD2000P	RD2000S	KINPIED09	220	880	215	60	1000	800
1000 x 900	RD2001	RD2001A	RD2001N	RD2001P	RD2001S	KINPIED09	270	880	265	60	1000	900
1200 x 800	RD2002	RD2002A	RD2002N	RD2002P	RD2002S	KINPIED11	220	1080	215	60	1200	800
1200 x 900	RD2003	RD2003A	RD2003N	RD2003P	RD2003S	KINPIED11	270	1080	265	60	1200	900
1400 x 800	RD2004	RD2004A	RD2004N	RD2004P	RD2004S	KINPIED11	220	1280	215	250	1400	800
1400 x 900	RD2005	RD2005A	RD2005N	RD2005P	RD2005S	KINPIED11	270	1280	265	250	1400	900
1600 x 800	RD2006	RD2006A	RD2006N	RD2006P	RD2006S	KINPIED11	220	1480	215	400	1600	800
1600 x 900	RD2007	RD2007A	RD2007N	RD2007P	RD2007S	KINPIED11	270	1480	265	400	1600	900
1800 x 800	RD2008	RD2008A	RD2008N	RD2008P	RD2008S	KINPIED11	220	1680	215	500	1800	800
1800 x 900	RD2009	RD2009A	RD2009N	RD2009P	RD2009S	KINPIED11	227	1680	265	500	1800	900

Rectangular tray with waste on the long side of the tray
White only

Size	Product codes		See dimensions on next page				
	White	Feet	B	C	D	X	Y
1400 x 800	RD330	KINPIED11	520	680	515	1400	800
1400 x 900	RD331	KINPIED11	520	780	515	1400	900
1600 x 800	RD332	KINPIED11	620	680	615	1600	800
1600 x 900	RD333	KINPIED11	620	780	615	1600	900
1800 x 800	RD336	KINPIED11	720	680	715	1800	800
1800 x 900	RD337	KINPIED11	720	780	715	1800	900



Recommended feet for raised installation

	Code
Kineline feet for 800, 900 and 1000mm trays (5 feet)	KINPIED09
Kineline feet for 1200-1800mm trays (8 feet)	KINPIED11



Kineline 1800 x 900 - black

Dimensions

See table for measurements

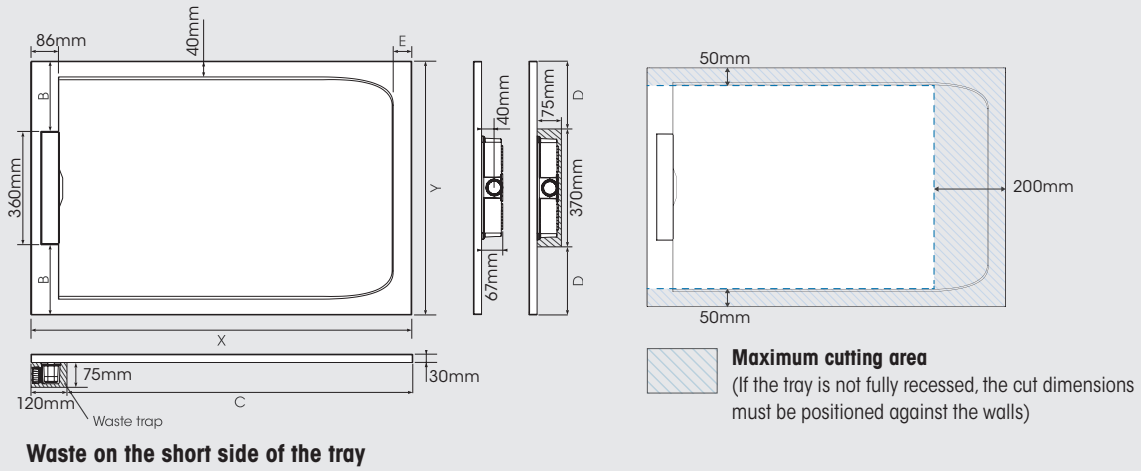

Waste on the long side of the tray – Only available in white and in selected sizes

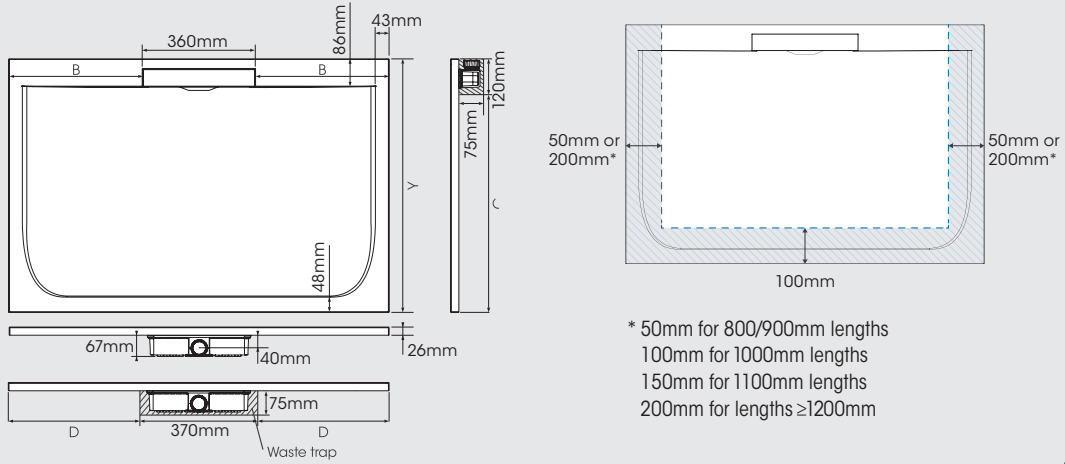

All measurements in mm





Enclosures

CONTENTS

WALK-IN	24 - 57
KINESTYLE	58 - 67
SMART DESIGN	68 - 85



Anti-limescale

Our range of enclosures comes with our anti-limescale treatment. This minimises the build up of calcium deposits and dirt on the glass reducing the need to clean.



Easy access

Our enclosures can be used with shower trays or with wet room designs depending on your needs.



Easy maintenance

Our enclosures are designed with ease of maintenance in mind. With detachable rollers for easy cleaning and the anti-limescale on the glass to keep our enclosures looking as good as new.



10 year warranty

Every one of our cubicles comes with a warranty* of up to 10 years, fully backed by SFA Saniflo UK Ltd.

* For full warranty details, please visit kinedo.co.uk

Alpha Solo

For simple clean lines the Alpha solo is perfect. This 10mm glass walk-in panel requires no reinforcement bar, so it creates the perfect minimalist look with this simple stunning design. For a simple, stylish, designer look walk-in space choose the Alpha Solo.

- Chrome aluminium profile
- Chrome cover strip at the bottom of the panel
- Anti-limescale treatment comes as standard
- 10mm glass
- 2 metres in height

Product codes and dimensions

Size	Product codes	Dimensions A
800	PA604CTNE	770 - 790
900	PA605CTNE	870 - 890
1000	PA606CTNE	970 - 990
1200	PA607CTNE	1170 - 1190
1400	PA608CTNE	1370 - 1390

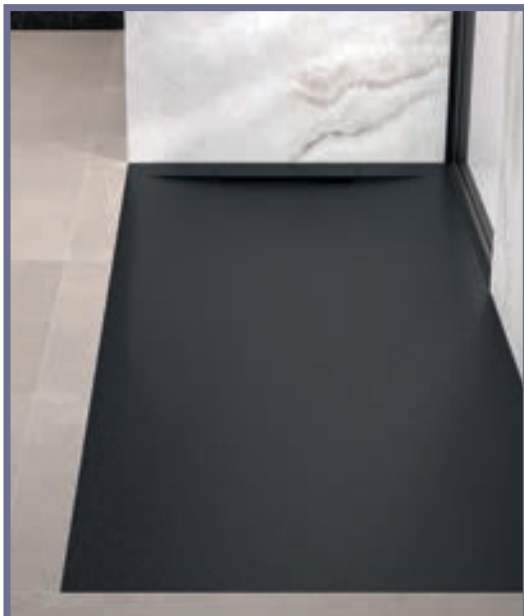

Why not add a Kineline tray to the Alpha Solo
see page 18 for details

Dimensions



Colours



Chrome

Installation



Walk-in

Features

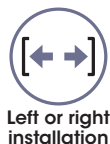



Alpha Solo – chrome profile

Kinequartz Square

Neat square brackets on this walk-in panel create a light and bright showering area. Minimal profile showcases whichever of the 3 glass types you choose to it's full potential. Smoked mirror glass or the mirror strip creates a different look for a simple walk-in space.

- Wall fixing by brackets for a neat finish to your showering area
- 3 glass finishes to choose from:
 - Transparent
 - Smoked mirror
 - Glass with mirror strip
- 2 chrome reinforcement bars to choose from:
 - Straight reinforcement bar (1200mm max) that can be placed straight or diagonally
 - Floor to ceiling bar (2800mm max), if installing with a tray, the tray height should not exceed 180mm
- Optional chrome silicone strip at the bottom of the panel and against the wall
- A second wall panel can be added to a larger shower to reduce splashing



Kinequartz square – chrome profile – transparent glass

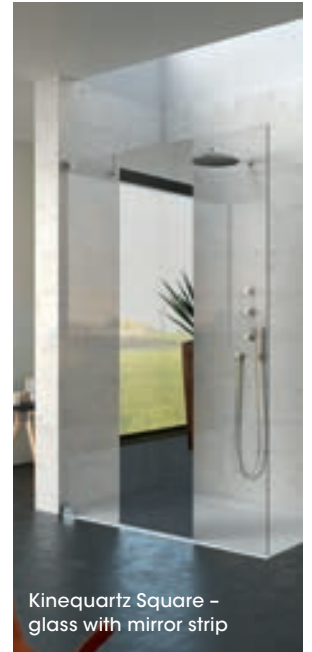

Kinequartz Square – glass with mirror strip

Product codes and dimensions

With straight reinforcement bar				
Size	Transparent glass	Smoked mirror glass	Glass with mirror strip	Dimensions A1
700	PA8010C2CE	PA8010CFME	-	685 - 690
800	PA8011C2CE	PA8011CFME	-	785 - 790
900	PA8012C2CE	PA8012CFME	-	885 - 890
1000	PA8013C2CE	PA8013CFME	-	985 - 990
1100	PA8014C2CE	PA8014CFME	-	1085 - 1090
1200	PA8015C2CE	PA8015CFME	PA8015CBME	1185 - 1190
1400	PA8016C2CE	PA8016CFME	PA8016CBME	1385 - 1390
1600	PA8017C2CE	PA8017CFME	PA8017CBME	1585 - 1590

With floor to ceiling bar				
Size	Transparent glass	Smoked mirror glass	Glass with mirror strip	Dimensions A1
700	PA8010C2CEM	PA8010CFMEM	-	685 - 690
800	PA8011C2CEM	PA8011CFMEM	-	785 - 790
900	PA8012C2CEM	PA8012CFMEM	-	885 - 890
1000	PA8013C2CEM	PA8013CFMEM	-	985 - 990
1100	PA8014C2CEM	PA8014CFMEM	-	1085 - 1090
1200	PA8015C2CEM	PA8015CFMEM	PA8015CBMEM	1185 - 1190
1400	PA8016C2CEM	PA8016CFMEM	PA8016CBMEM	1385 - 1390
1600	PA8017C2CEM	PA8017CFMEM	PA8017CBMEM	1585 - 1590

Dimensions

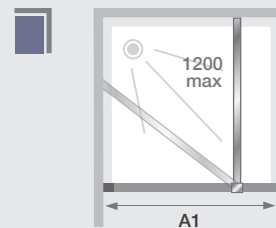

Reversible installation.

All measurements in mm

Colours



Chrome

Installation



Walk-in

Features

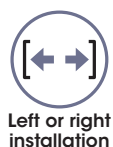



Kinequartz Square - chrome profile - smoked mirror glass - with straight reinforcement bar

Kinequartz Square Duo

Neat square brackets on this walk-in panel create a light and bright showering area. Minimal profile showcases this walk-in screen to it's full potential. The Duo version includes a 180° pivot section for reduced splash.

- Wall fixing by brackets for a neat finish to your showering area
- Pivot section with opening fixed every 45°
- 2 chrome straight reinforcement bars to choose from:
 - Straight reinforcement bar (1200mm max) that can be placed straight or diagonally
 - Floor to ceiling bar (2800mm max), if installing with a tray, the tray height should not exceed 180mm
- Comes with optional chrome silicone strip at the bottom of the panel and against the wall
- A second wall panel can be added to a larger shower to reduce splashing

Product codes and dimensions

With straight reinforcement bar						
Size	With 400mm pivot section		With 600mm pivot section		Dimensions	
	Brackets on the left	Brackets on the right	Brackets on the left	Brackets on the right	A2	A3
900	PA8030C2CEG	PA8030C2CED	PA8050C2CEG	PA8050C2CED	885 - 890	400 or 600
1000	PA8031C2CEG	PA8031C2CED	PA8051C2CEG	PA8051C2CED	985 - 990	400 or 600
1100	PA8032C2CEG	PA8032C2CED	PA8052C2CEG	PA8052C2CED	1085 - 1090	400 or 600
1200	PA8033C2CEG	PA8033C2CED	PA8053C2CEG	PA8053C2CED	1185 - 1190	400 or 600
1400	PA8034C2CEG	PA8034C2CED	PA8054C2CEG	PA8054C2CED	1385 - 1390	400 or 600
1600	PA8035C2CEG	PA8035C2CED	PA8055C2CEG	PA8055C2CED	1585 - 1590	400 or 600

With floor to ceiling bar						
Size	With 400mm pivot section		With 600mm pivot section		Dimensions	
	Brackets on the left	Brackets on the right	Brackets on the left	Brackets on the right	A2	A3
900	PA8030C2CEMG	PA8030C2CEMD	PA8050C2CEMG	PA8050C2CEMD	885 - 890	400 or 600
1000	PA8031C2CEMG	PA8031C2CEMD	PA8051C2CEMG	PA8051C2CEMD	985 - 990	400 or 600
1100	PA8032C2CEMG	PA8032C2CEMD	PA8052C2CEMG	PA8052C2CEMD	1085 - 1090	400 or 600
1200	PA8033C2CEMG	PA8033C2CEMD	PA8053C2CEMG	PA8053C2CEMD	1185 - 1190	400 or 600
1400	PA8034C2CEMG	PA8034C2CEMD	PA8054C2CEMG	PA8054C2CEMD	1385 - 1390	400 or 600
1600	PA8035C2CEMG	PA8035C2CEMD	PA8055C2CEMG	PA8055C2CEMD	1585 - 1590	400 or 600

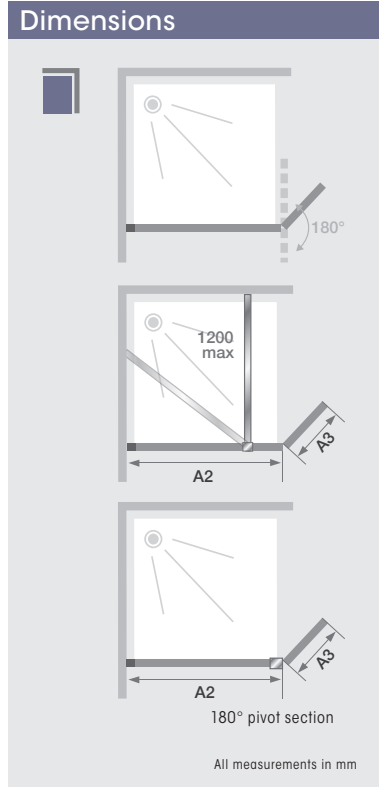

Colours



Chrome

Installation



Walk-in

Features





Kinequartz Square Duo - chrome profile - with straight reinforcement bar

Kinequartz Profile Solo

Walk-in panel with full chrome profile and 3 glass types to choose from can help you create that perfect shower space. Smoked mirror glass or the mirror strip creates a different look for a simple walk-in space. Two different straight reinforcement bars available to finish the look.

- Wall fixing profile with easy adjustment
- 3 glass finishes to choose from:
 - Transparent
 - Smoked mirror
 - Glass with mirror strip
- Glass with central mirror band: interior/exterior (width 500mm)
- 2 chrome straight reinforcement bars to choose from:
 - Straight reinforcement bar (1200mm max) that can be placed straight or diagonally
 - Floor to ceiling bar (2800mm max), if installing with a tray, the tray height should not exceed 180mm
- Optional chrome silicone strip at the bottom of the panel and against the wall
- A second wall panel can be added to a larger shower to reduce splashing

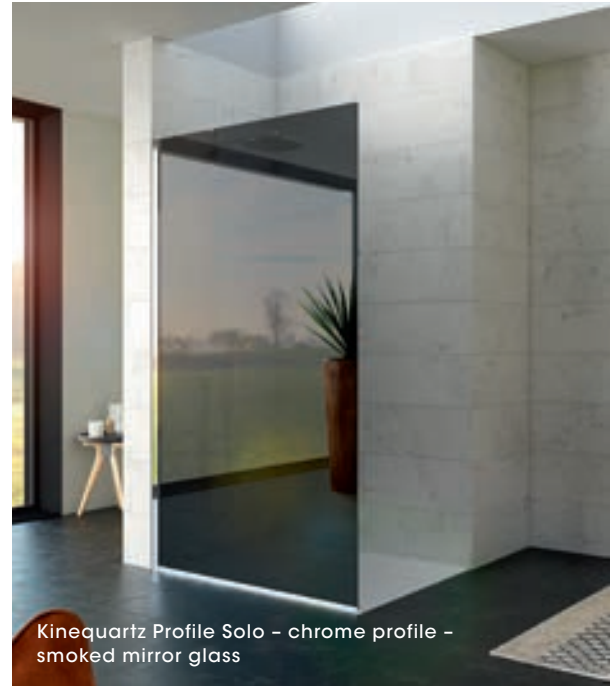

Kinequartz Profile Solo – chrome profile – smoked mirror glass

Product codes and dimensions

With straight reinforcement bar					
Size	Transparent glass	Smoked mirror glass	Glass with mirror strip	Dimensions	
				A4	A5
700	PA8000C2CE	PA8000CFME	-	675 - 690	655
800	PA8001C2CE	PA8001CFME	-	775 - 790	755
900	PA8002C2CE	PA8002CFME	-	875 - 890	855
1000	PA8003C2CE	PA8003CFME	-	975 - 990	955
1100	PA8004C2CE	PA8004CFME	-	1075 - 1090	1055
1200	PA8005C2CE	PA8005CFME	PA8005CBME	1175 - 1190	1155
1400	PA8006C2CE	PA8006CFME	PA8006CBME	1375 - 1390	1355
1600	PA8007C2CE	PA8007CFME	PA8007CBME	1575 - 1590	1555

With floor to ceiling bar					
Size	Transparent glass	Smoked mirror glass	Glass with mirror strip	Dimensions	
				A4	A5
700	PA8000C2CEM	PA8000CFMEM	-	675 - 690	655
800	PA8001C2CEM	PA8001CFMEM	-	775 - 790	755
900	PA8002C2CEM	PA8002CFMEM	-	875 - 890	855
1000	PA8003C2CEM	PA8003CFMEM	-	975 - 990	955
1100	PA8004C2CEM	PA8004CFMEM	-	1075 - 1090	1055
1200	PA8005C2CEM	PA8005CFMEM	PA8005CBMEM	1175 - 1190	1155
1400	PA8006C2CEM	PA8006CFMEM	PA8006CBMEM	1375 - 1390	1355
1600	PA8007C2CEM	PA8007CFMEM	PA8007CBMEM	1575 - 1590	1555

Dimensions

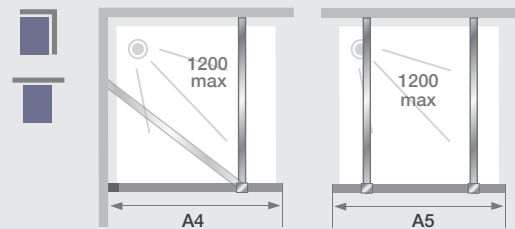

Reversible installation. For installation against a wall, a second straight reinforcement bar is required.

All measurements in mm

Colours



Chrome

Installation



Walk-in

For installation against a wall a second straight reinforcement bar is needed: Articulated bar RENFORT21, Floor to ceiling bar MATO5

Features

10 year warranty

Height 2000mm

Easy maintenance

Left or right installation

Ease of installation

Easy access

Choice of reinforcement bar options

Anti-limescale

8mm glass



Kinequartz Profile Solo – glass with mirror strip – with straight reinforcement bar

Kinequartz Profile Duo

Walk-in panel with full chrome profile creates a perfect showering space. Two different straight reinforcement bars available to finish the look. The Duo version includes a 180° pivot section for reduced splash.

- Wall fixing profile with easy adjustment
- Pivot section with opening fixed every 45°
- 2 chrome straight reinforcement bars to choose from:
 - Straight reinforcement bar (1200mm max) that can be placed straight or diagonally
 - Floor to ceiling bar (2800mm max). If installing with a tray, the tray height should not exceed 180mm
- Optional chrome silicone strip at the bottom of the panel and against the wall
- A second wall panel can be added to a larger shower to reduce splashing

Product codes and dimensions

With straight reinforcement bar						
Size	With 400mm pivot section		With 600mm pivot section		A6	A7
	Brackets on the left	Brackets on the right	Brackets on the left	Brackets on the right	Fixed panel	Pivot section
900	PA8020C2CEG	PA8020C2CED	PA8040C2CEG	PA8040C2CED	875 - 890	400 or 600
1000	PA8021C2CEG	PA8021C2CED	PA8041C2CEG	PA8041C2CED	975 - 990	400 or 600
1100	PA8022C2CEG	PA8022C2CED	PA8042C2CEG	PA8042C2CED	1075 - 1090	400 or 600
1200	PA8023C2CEG	PA8023C2CED	PA8043C2CEG	PA8043C2CED	1175 - 1190	400 or 600
1400	PA8024C2CEG	PA8024C2CED	PA8044C2CEG	PA8044C2CED	1375 - 1390	400 or 600
1600	PA8025C2CEG	PA8025C2CED	PA8045C2CEG	PA8045C2CED	1575 - 1590	400 or 600

With floor to ceiling bar						
Size	With 400mm pivot section		With 600mm pivot section		A6	A7
	Brackets on the left	Brackets on the right	Brackets on the left	Brackets on the right	Fixed panel	Pivot section
900	PA8020C2CEMG	PA8020C2CEMD	PA8040C2CEMG	PA8040C2CEMD	875 - 890	400 or 600
1000	PA8021C2CEMG	PA8021C2CEMD	PA8041C2CEMG	PA8041C2CEMD	975 - 990	400 or 600
1100	PA8022C2CEMG	PA8022C2CEMD	PA8042C2CEMG	PA8042C2CEMD	1075 - 1090	400 or 600
1200	PA8023C2CEMG	PA8023C2CEMD	PA8043C2CEMG	PA8043C2CEMD	1175 - 1190	400 or 600
1400	PA8024C2CEMG	PA8024C2CEMD	PA8044C2CEMG	PA8044C2CEMD	1375 - 1390	400 or 600
1600	PA8025C2CEMG	PA8025C2CEMD	PA8045C2CEMG	PA8045C2CEMD	1575 - 1590	400 or 600

Dimensions

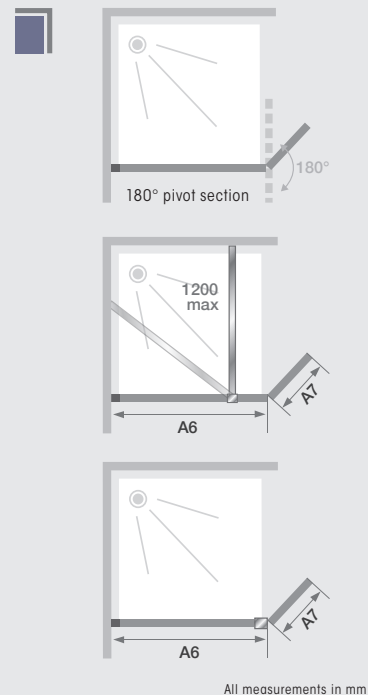

Colours



Chrome

Installation



Walk-in

Features

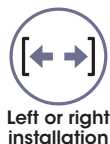



Kinequartz Profile Duo – chrome profile – with floor to ceiling straight reinforcement bar

Kinestyle Solo

Simple yet stylish walk-in panel with full length chrome profile and simple straight reinforcement bar. This classic walk-in panel will look great no matter what your bathroom design.

- Chrome effect profile
- Chrome straight reinforcement bar (1000mm max)
- 8mm glass
- 2000mm in height
- Anti-limescale treatment as standard
- Different style straight reinforcement bars available – Articulated, straight, floor to ceiling

Product codes and dimensions

Size	Product codes	Dimensions A8
700	PA1760CTNE	675 - 690
800	PA1761CTNE	775 - 790
900	PA1762CTNE	875 - 890
1000	PA1763CTNE	975 - 990
1200	PA1764CTNE	1175 - 1190
1400	PA1765CTNE	1375 - 1390

For installation against a wall a second reinforcement bar is needed

Straight reinforcement bar	RENFORT21
Floor to ceiling bar	MAT01

Dimensions

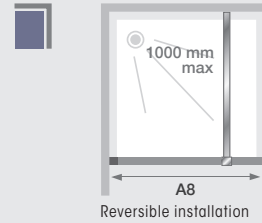

All measurements in mm

Colours



Chrome

Installation



Walk-in

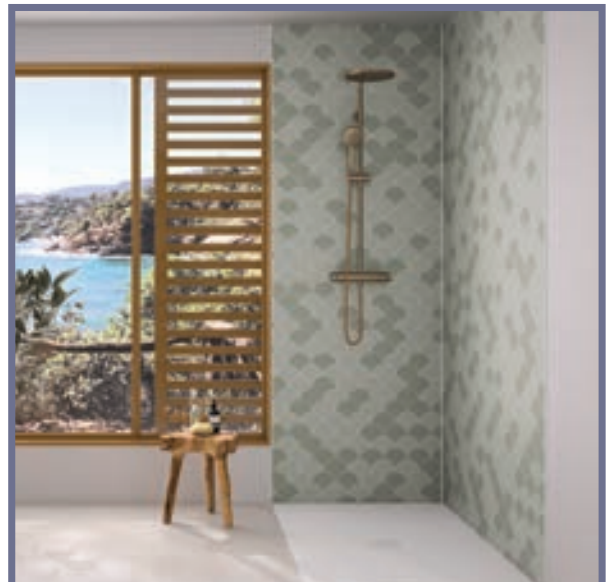

Why not add Kinewall bathroom wall panels to Kinestyle Solo see page 136 for details

Features

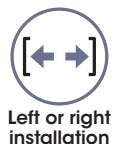



Kinestyle Solo – chrome profile – with straight reinforcement bar

Ekinox +

With Ekinox +, let your imagination run wild and design your own showering space. No matter how big or small your bathroom is, the Ekinox range can be used together to create the perfect walk in shower, however your bathroom is configured.

Here are some examples to inspire you:

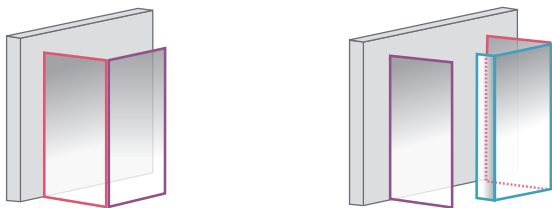
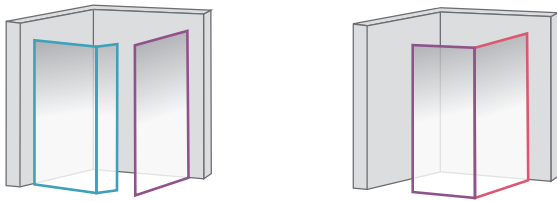
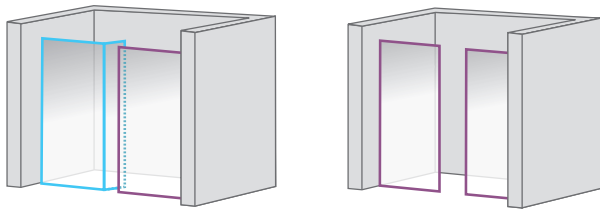

- Key
- Ekinox Solo
 - Ekinox Duo
 - Ekinox Corner
(to be used with Ekinox Solo or Duo)

Colours



Chrome



Copper



Brushed cobalt blue aluminium

Installation



Walk-in



Why not add a Kinemoon tray to the Ekinox + see page 10 for details

Features





Ekinox Solo and Ekinox Corner - brushed cobalt blue aluminium profile - floor to ceiling reinforcement bar

Ekinox Solo

Walk-in panel with a choice of 3 profile colours, brushed stainless steel, copper or cobalt blue create a stunning different look to your bathroom by a simple profile. Reinforcement bars available in matching profile colour to complete the look.

- Brushed stainless steel, copper or brushed cobalt blue aluminium profile
- 2 chrome reinforcement bars to choose from:
 - Straight reinforcement bar (1200mm max)
 - Floor to ceiling bar (2800mm max)

Product codes and dimensions

With straight bar					
Size	Brushed stainless steel	Copper	Brushed cobalt blue aluminium	A9	A10
700	PA4210ITNE	PA4210RTNE	PA4210KTNE	675 - 690	665
800	PA4211ITNE	PA4211RTNE	PA4211KTNE	775 - 790	765
900	PA4212ITNE	PA4212RTNE	PA4212KTNE	875 - 890	865
1000	PA4213ITNE	PA4213RTNE	PA4213KTNE	975 - 990	965
1200	PA4214ITNE	PA4214RTNE	PA4214KTNE	1175 - 1190	1165
1400	PA4215ITNE	PA4215RTNE	PA4215KTNE	1375 - 1390	1365

With floor to ceiling bar					
Size	Brushed stainless steel	Copper	Brushed cobalt blue aluminium	A9	A10
700	PA4210ITNEM	PA4210RTNEM	PA4210KTNEM	675 - 690	665
800	PA4211ITNEM	PA4211RTNEM	PA4211KTNEM	775 - 790	765
900	PA4212ITNEM	PA4212RTNEM	PA4212KTNEM	875 - 890	865
1000	PA4213ITNEM	PA4213RTNEM	PA4213KTNEM	975 - 990	965
1200	PA4214ITNEM	PA4214RTNEM	PA4214KTNEM	1175 - 1190	1165
1400	PA4215ITNEM	PA4215RTNEM	PA4215KTNEM	1375 - 1390	1365

For installation against a wall a second reinforcement bar is needed

Straight reinforcement bar – Brushed stainless steel	RENFORT33
Straight reinforcement bar – Copper	RENFORT34
Straight reinforcement bar – Cobalt blue	RENFORT35
Floor to ceiling bar – Brushed stainless steel	MAT010
Floor to ceiling bar – Copper	MAT011
Floor to ceiling bar – Cobalt blue	MAT012

Dimensions

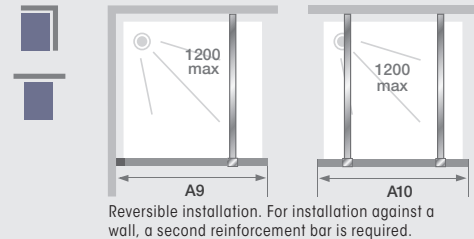

All measurements in mm

Colours

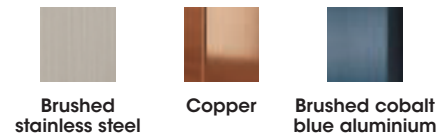

Brushed stainless steel

Copper

Brushed cobalt blue aluminium

Installation



Walk-in

Features

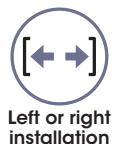



Ekinox Solo - brushed stainless steel profile - with floor to ceiling straight reinforcement bar

Ekinox Duo

Walk-in panel with a choice of 3 profile colours, brushed stainless steel, copper or cobalt blue create a stunning different look to your bathroom by a simple profile. Reinforcement bars available in matching profile colour to complete the look. The Duo version includes a 180° pivot section for reduced splash.

- Reduced splash thanks to the pivoting section
- Pivot section easily holds in position
- Brushed stainless steel, copper or brushed cobalt blue aluminium profile
- 2 chrome reinforcement bars to choose from:
 - Straight reinforcement bar (1200mm max)
 - Floor to ceiling bar (2800mm max)

Product codes and dimensions

With straight bar					
Size	Brushed stainless steel	Copper	Brushed cobalt blue aluminium	Fixed panel A11	Pivot section A12
700	PA4220ITNE	PA4220RTNE	PA4220KTNE	675 - 690	450
800	PA4221ITNE	PA4221RTNE	PA4221KTNE	775 - 790	450
900	PA4222ITNE	PA4222RTNE	PA4222KTNE	875 - 890	450
1000	PA4223ITNE	PA4223RTNE	PA4223KTNE	975 - 990	450
1200	PA4224ITNE	PA4224RTNE	PA4224KTNE	1175 - 1190	450
1400	PA4225ITNE	PA4225RTNE	PA4225KTNE	1375 - 1390	450

With floor to ceiling bar - left hand wall					
Size	Brushed stainless steel	Copper	Brushed cobalt blue aluminium	Fixed panel A11	Pivot section A12
700	PA4220ITNEMG	PA4220RTNEMG	PA4220KTNEMG	675 - 690	450
800	PA4221ITNEMG	PA4221RTNEMG	PA4221KTNEMG	775 - 790	450
900	PA4222ITNEMG	PA4222RTNEMG	PA4222KTNEMG	875 - 890	450
1000	PA4223ITNEMG	PA4223RTNEMG	PA4223KTNEMG	975 - 990	450
1200	PA4224ITNEMG	PA4224RTNEMG	PA4224KTNEMG	1175 - 1190	450
1400	PA4225ITNEMG	PA4225RTNEMG	PA4225KTNEMG	1375 - 1390	450

With floor to ceiling bar - right hand wall					
Size	Brushed stainless steel	Copper	Brushed cobalt blue aluminium	Fixed panel A11	Pivot section A12
700	PA4220ITNEMD	PA4220RTNEMD	PA4220KTNEMD	675 - 690	450
800	PA4221ITNEMD	PA4221RTNEMD	PA4221KTNEMD	775 - 790	450
900	PA4222ITNEMD	PA4222RTNEMD	PA4222KTNEMD	875 - 890	450
1000	PA4223ITNEMD	PA4223RTNEMD	PA4223KTNEMD	975 - 990	450
1200	PA4224ITNEMD	PA4224RTNEMD	PA4224KTNEMD	1175 - 1190	450
1400	PA4225ITNEMD	PA4225RTNEMD	PA4225KTNEMD	1375 - 1390	450

Dimensions

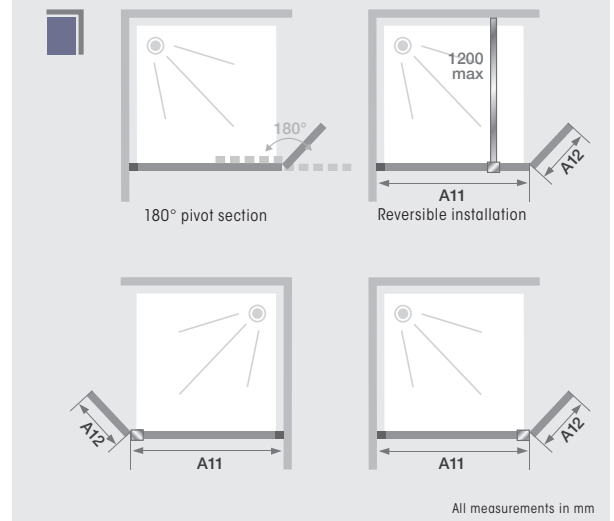

Colours

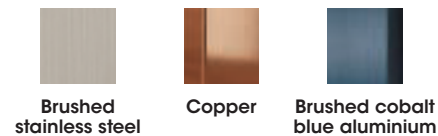

Installation



Features

- 10 year warranty
- Height 2070mm
- Easy maintenance
- Left or right installation
- Ease of installation
- Easy access
- Choice of reinforcement bar options
- Anti-limescale
- 6mm glass



Ekinox Duo - brushed cobalt blue aluminium profile - with floor to ceiling straight reinforcement bar

Ekinox Corner

Fixed panel for use with Ekinox solo or Duo to create corner installations. Available in a choice of 3 profile colours, brushed stainless steel, copper or cobalt blue create a stunning different look to your bathroom by a simple profile.

- Brushed stainless steel, copper or brushed cobalt blue aluminium profile

Product codes and dimensions

Size	Brushed stainless steel	Copper	Brushed cobalt blue aluminium	A13
700	PA4260ITNE	PA4260RTNE	PA4260KTNE	675 - 690
800	PA4261ITNE	PA4261RTNE	PA4261KTNE	775 - 790
900	PA4262ITNE	PA4262RTNE	PA4262KTNE	875 - 890
1000	PA4263ITNE	PA4263RTNE	PA4263KTNE	975 - 990

Dimensions

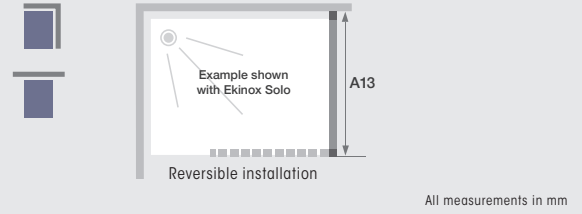

Colours

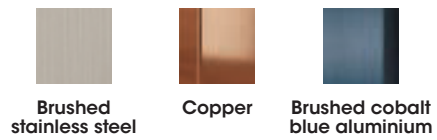

Installation



Why not add Kinewall bathroom wall panels to Ekinox Corner see page 136 for details

Features

- 10 year warranty
- Height 2070mm
- Easy maintenance
- Left or right installation
- Ease of installation
- Easy access
- Choice of reinforcement bar options
- Anti-limescale
- 6mm glass



Ekinox Corner - copper profile - with straight reinforcement bar

Smart Design Solo

Stylish walk-in panel available in 3 profile colours black, white and chrome and with 2 glass options to choose from transparent and cosmos. This range offers choice to create your perfect walk-in shower whatever your bathroom décor.

- Aluminium profile available in chrome, white or black
- 2 finishes of glass available: transparent and transparent with a middle band (cosmos)
- Reinforcement bar or floor to ceiling bar available to match the profile colour chosen
- Reversible panel
- Pivot section available to extend the Solo panel – please see page 46 for details
- Additional reinforcement bar needed for against a wall installation

Dimensions

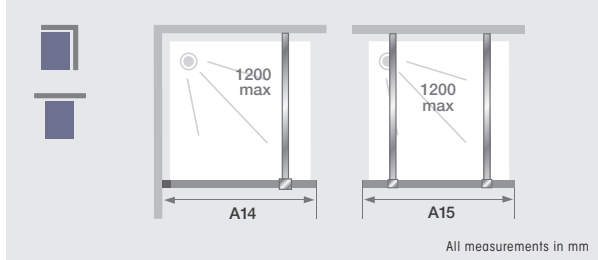

Colours



Chrome White Black

Installation



Walk-in

For installation against a wall a second reinforcement bar is needed

Straight reinforcement bar – White	RENFORT31
Straight reinforcement bar – Chrome	RENFORT23
Straight reinforcement bar – Black	RENFORT30
Floor to ceiling bar – White	MAT013
Floor to ceiling bar – Chrome	MAT014
Floor to ceiling bar – Black	MAT015

Product codes and dimensions

Size	With straight bar			Dimensions	
	White profile	Chrome profile	Black profile	A14	A15
Height 1983mm	Transparent glass	Transparent glass	Transparent glass	A14	A15
700	PA90300BTNE	PA90300CTNE	PA90300NTNE	640 - 655	630
750	PA90301BTNE	PA90301CTNE	PA90301NTNE	690 - 705	680
800	PA90302BTNE	PA90302CTNE	PA90302NTNE	740 - 755	730
850	PA90303BTNE	PA90303CTNE	PA90303NTNE	790 - 805	780
900	PA90304BTNE	PA90304CTNE	PA90304NTNE	840 - 855	830
950	PA90305BTNE	PA90305CTNE	PA90305NTNE	890 - 905	880
1000	PA90306BTNE	PA90306CTNE	PA90306NTNE	940 - 955	930
1100	PA90307BTNE	PA90307CTNE	PA90307NTNE	1040 - 1055	1030
1200	PA90308BTNE	PA90308CTNE	PA90308NTNE	1140 - 1155	1130
1300	PA90309BTNE	PA90309CTNE	PA90309NTNE	1240 - 1255	1230
1400	PA90310BTNE	PA90310CTNE	PA90310NTNE	1340 - 1355	1330
Height 2257mm	Transparent glass	Transparent glass	Transparent glass	Transparent glass	
800	PA90311BTNE	PA90311CTNE	-	740 - 755	730
900	PA90312BTNE	PA90312CTNE	-	840 - 855	830
1000	PA90313BTNE	PA90313CTNE	-	940 - 955	930
1200	PA90314BTNE	PA90314CTNE	-	1140 - 1155	1130

Size	With straight bar		Dimensions	
	White profile	Chrome profile	A14	A15
Height 1983mm	Cosmos glass	Cosmos glass	A14	A15
700	PA90300BCOE	PA90300CCOE	640 - 655	630
750	-	-	690 - 705	680
800	PA90302BCOE	PA90302CCOE	740 - 755	730
850	-	-	790 - 805	780
900	PA90304BCOE	PA90304CCOE	840 - 855	830
950	-	-	890 - 905	880
1000	PA90306BCOE	PA90306CCOE	940 - 955	930
1100	PA90307BCOE	PA90307CCOE	1040 - 1055	1030
1200	PA90308BCOE	PA90308CCOE	1140 - 1155	1130
1300	PA90309BCOE	PA90309CCOE	1240 - 1255	1230
1400	PA90310BCOE	PA90310CCOE	1340 - 1355	1330

Size	With floor to ceiling bar			Dimensions	
	White profile	Chrome profile	Black profile	A14	A15
Height 1983mm	Transparent glass	Transparent glass	Transparent glass	A14	A15
700	PA90300BTNEM	PA90300CTNEM	PA90300NTNEM	640 - 655	630
750	PA90301BTNEM	PA90301CTNEM	PA90301NTNEM	690 - 705	680
800	PA90302BTNEM	PA90302CTNEM	PA90302NTNEM	740 - 755	730
850	PA90303BTNEM	PA90303CTNEM	PA90303NTNEM	790 - 805	780
900	PA90304BTNEM	PA90304CTNEM	PA90304NTNEM	840 - 855	830
950	PA90305BTNEM	PA90305CTNEM	PA90305NTNEM	890 - 905	880
1000	PA90306BTNEM	PA90306CTNEM	PA90306NTNEM	940 - 955	930
1100	PA90307BTNEM	PA90307CTNEM	PA90307NTNEM	1040 - 1055	1030
1200	PA90308BTNEM	PA90308CTNEM	PA90308NTNEM	1140 - 1155	1130
1300	PA90309BTNEM	PA90309CTNEM	PA90309NTNEM	1240 - 1255	1230
1400	PA90310BTNEM	PA90310CTNEM	PA90310NTNEM	1340 - 1355	1330

Size	With floor to ceiling bar		Dimensions	
	White profile	Chrome profile	A14	A15
Height 1983mm	Cosmos glass	Cosmos glass	A14	A15
700	PA90300BCOEM	PA90300CCOEM	640 - 655	630
750	-	-	690 - 705	680
800	PA90302BCOEM	PA90302CCOEM	740 - 755	730
850	-	-	790 - 805	780
900	PA90304BCOEM	PA90304CCOEM	840 - 855	830
950	-	-	890 - 905	880
1000	PA90306BCOEM	PA90306CCOEM	940 - 955	930
1100	PA90307BCOEM	PA90307CCOEM	1040 - 1055	1030
1200	PA90308BCOEM	PA90308CCOEM	1140 - 1155	1130
1300	PA90309BCOEM	PA90309CCOEM	1240 - 1255	1230
1400	PA90310BCOEM	PA90310CCOEM	1340 - 1355	1330

Features

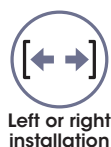



Smart Design Solo – chrome profile – cosmos glass – with straight reinforcement bar

Smart Design Duo

Pivoting panel available to add to Smart Design Solo to create a Duo walk-in panel. Available in 3 profile colours black, white and chrome and with 2 glass options to choose from transparent and cosmos. The Duo version includes a 180° pivot section for reduced splash. This range offers choice to create your perfect walk-in shower whatever your bathroom decor.

- Aluminium profile available in chrome, white or black
- Reinforcement bar available to match the profile colour chosen
- Pivot section can be fitted to open inwards or outwards 180° opening
- 2 finishes of glass available: transparent, or cosmos
- Pivot section easily holds in position
- Reversible panel
- Order the Solo and then add the pivot section to create the Duo

Product codes and dimensions

	Code	A19
350mm Duo screen with Cosmos glass and white profile	PA985BCOE	375
350mm Duo screen with transparent glass and white profile	PA985BTNE	375
350mm Duo screen with Cosmos glass and chrome profile	PA985CCOE	375
350mm Duo screen with transparent glass and chrome profile	PA985CTNE	375
350mm Duo screen with transparent glass and black profile	PA985NTNE	375

On dimensions drawing the A18 measurement will depend on Smart design Solo panel chosen. For lengths and dimensions please see page 44.

Dimensions

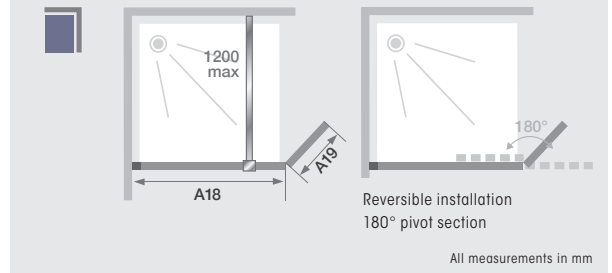

Colours



Chrome

White

Black

Installation



Features

10 year warranty	Height 2000mm	Easy maintenance	Left or right installation	Ease of installation	Easy access	Choice of reinforcement bar options	Anti-limescale	6mm glass



Smart Design Duo - chrome profile - cosmos glass - with straight reinforcement bar

Smart Design Solo Factory

This modern industrial walk-in panel is available with black profile and screen printed black lines on the glass to create the perfect New York Loft look.

- Black profile
- Screen print glass with black lines for industrial look
- 2 chrome reinforcement bars to choose from:
 - Straight reinforcement bar (1200mm max)
 - Floor to ceiling bar (2800mm max)

Product codes and dimensions

Size	Product codes		Dimensions
	With straight bar	With floor to ceiling bar	A16
700	PA90300N2BVE	PA90300N2BVEM	640 - 655
800	PA90302N2BVE	PA90302N2BVEM	740 - 755
900	PA90304N2BVE	PA90304N2BVEM	840 - 855
1000	PA90306N2BVE	PA90306N2BVEM	940 - 955
1100	PA90307N2BVE	PA90307N2BVEM	1040 - 1055
1200	PA90308N2BVE	PA90308N2BVEM	1140 - 1155

Dimensions

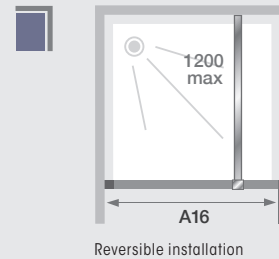

All measurements in mm

Colours



Black

Installation



Walk-in

Features



10 year warranty



Height 2000mm



Easy maintenance

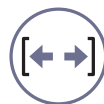

Left or right installation



Ease of installation



Easy access

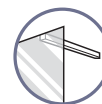

Choice of reinforcement bar options



Anti-limescale



6mm glass



Smart Design Solo Factory - black profile - screen print glass - with floor to ceiling straight reinforcement bar

Smart Design Solo Nordic

Perfect for a simple Scandi designed bathroom, this natural oak look profile creates a perfect walk-in shower.

- Natural oak look profile
- 2 chrome reinforcement bars to choose from:
 - Straight reinforcement bar (1200mm max)
 - Floor to ceiling bar (2800mm max)

Product codes and dimensions

Size	Product codes		Dimensions
	With straight bar	With floor to ceiling bar	A17
700	PA90300CNTNE	PA90300CNTNEM	640 - 655
800	PA90302CNTNE	PA90302CNTNEM	740 - 755
900	PA90304CNTNE	PA90304CNTNEM	840 - 855
1000	PA90306CNTNE	PA90306CNTNEM	940 - 955
1100	PA90307CNTNE	PA90307CNTNEM	1040 - 1055
1200	PA90308CNTNE	PA90308CNTNEM	1140 - 1155
1300	PA90309CNTNE	PA90309CNTNEM	1240 - 1255
1400	PA90310CNTNE	PA90310CNTNEM	1340 - 1355

Dimensions

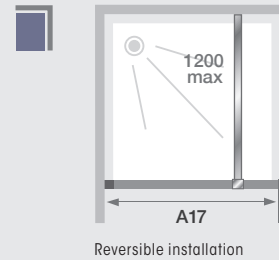

All measurements in mm

Colours



Natural oak look

Installation



Walk-in



Why not add a Kinerock Evo tray to the Smart Design Solo Nordic see page 14 for details

Features

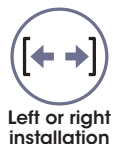



Smart Design Solo Nordic - natural oak look profile - with floor to ceiling straight reinforcement bar

Smart Design Solo P

The Smart Design range offers an innovative design for easy installation but with slim profiles, slender handles and no visible screws it is also sleek and modern in design. Solo P offers a pivoting glass panel that can fold flush against the wall for maximum space saving in your shower.

- Ideal for small bathrooms
- Aluminium profile available in chrome, white or black
- Pivot section can be fitted to open inwards or outwards 180° opening
- Reinforcement bar comes with sizes over 1100mm in chrome or black
- Reversible panel
- Sizes over 1000 come with a fixed panel and then pivoting door
- Anti-limescale treatment

Product codes and dimensions

Size	Product codes			Dimensions	
	White profile Transparent glass	Chrome profile Transparent glass	Black profile Transparent glass	A20	A21
700	PA90170BTNE	PA90170CTNE	PA90170NTNE	643 - 658	-
750	PA90171BTNE	PA90171CTNE	PA90171NTNE	693 - 708	-
800	PA90172BTNE	PA90172CTNE	PA90172NTNE	743 - 758	-
850	PA90173BTNE	PA90173CTNE	PA90173NTNE	793 - 808	-
900	PA90174BTNE	PA90174CTNE	PA90174NTNE	843 - 858	-
950	PA90175BTNE	PA90175CTNE	PA90175NTNE	893 - 908	-
1000	PA90176BTNE	PA90176CTNE	PA90176NTNE	943 - 958	-
1100	PA90180BTNE	PA90180CTNE	PA90180NTNE	1043 - 1058	345
1200	PA90181BTNE	PA90181CTNE	PA90181NTNE	1143 - 1158	445
1300	PA90182BTNE	PA90182CTNE	PA90182NTNE	1243 - 1258	445
1400	PA90183BTNE	PA90183CTNE	PA90183NTNE	1343 - 1358	545
1500	PA90184BTNE	PA90184CTNE	PA90184NTNE	1443 - 1458	645
1600	PA90185BTNE	PA90185CTNE	PA90185NTNE	1543 - 1558	745
1700	PA90186BTNE	PA90186CTNE	PA90186NTNE	1643 - 1658	845
1800	PA90187BTNE	PA90187CTNE	PA90187NTNE	1743 - 1758	945

Dimensions

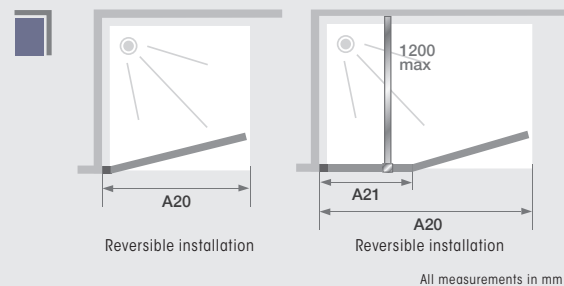

Colours



Chrome



White



Black

Installation

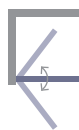

Walk-in

Features



10 year warranty



Height 2000mm



Easy maintenance

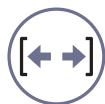

Left or right installation



Ease of installation



Easy access



Anti-limescale



6mm glass



Smart Design Solo P - black profile

Smart Design Solo S

The Smart Design range offers an innovative design for easy installation but with slim profiles, slender handles and no visible screws it is also sleek and modern in design. The Solo S is designed to create a wetroom look but it bi-folds flush against the wall for maximum space saving in smaller bathrooms.

- Ideal for small bathrooms
- Aluminium profile available in chrome or white
- Pivoting profile allows total opening of 180° either inwards or outwards
- Neat hinges to match the profile chosen
- Reversible panel
- Anti-limescale treatment

Product codes and dimensions

Size	Product codes		Dimensions	
	White profile	Chrome profile	A22	A23
	Transparent glass	Transparent glass		
700	PA90190BTNE	PA90190CTNE	643 - 658	325
750	PA90191BTNE	PA90191CTNE	693 - 708	350
800	PA90192BTNE	PA90192CTNE	743 - 758	375
850	PA90193BTNE	PA90193CTNE	793 - 808	400
900	PA90194BTNE	PA90194CTNE	843 - 858	425
950	PA90195BTNE	PA90195CTNE	893 - 908	450
1000	PA90196BTNE	PA90196CTNE	943 - 958	475

Dimensions

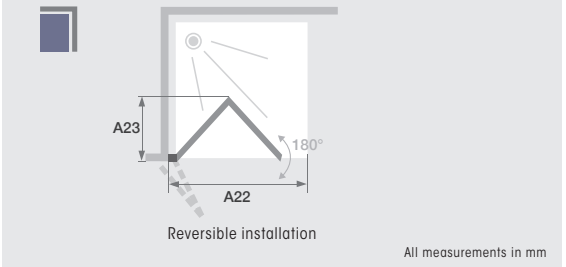

Colours

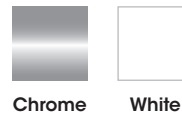

Chrome White

Installation



Walk-in

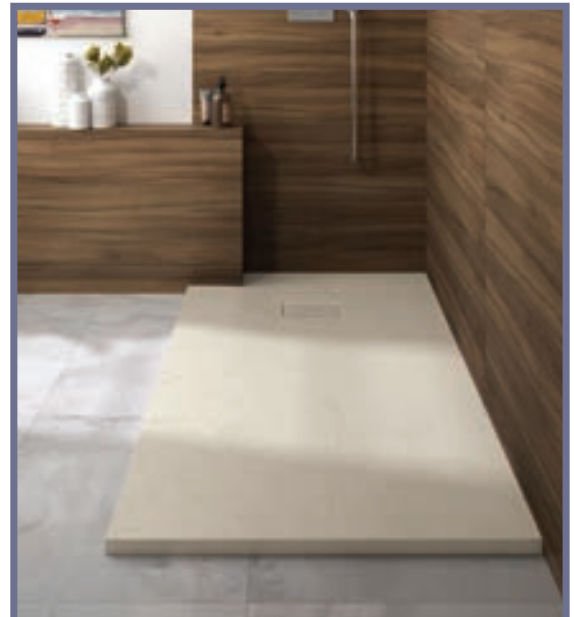

Why not add a Kinerock Evo tray to the Smart Design Solo S see page 14 for details

Features

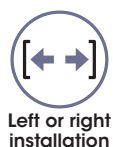



Smart Design Solo S - chrome profile

Supra Solo

This simple walk-in panel comes with 2 glass finishes transparent or stripe pattern glass and 2 profile choices white or chrome.

- 2 versions of glass to choose from – transparent or stripe patterned glass
- White or chrome profile
- Chrome reinforcement bar available (1000mm max)

Product codes and dimensions

Size	Product codes			Dimensions
	White profile		Chrome profile	
	Transparent glass	Stripe patterned glass	Transparent glass	A24
700	PA5230BTN	PA5230BBB	PA5230CTN	675 - 690
800	PA5231BTN	PA5231BBB	PA5231CTN	775 - 790
900	PA5232BTN	PA5232BBB	PA5232CTN	875 - 890
1000	PA5233BTN	PA5233BBB	PA5233CTN	975 - 990
1200	PA5235BTN	PA5235BBB	PA5235CTN	1175 - 1190

Alternative straight reinforcement bar:

Articulated Chrome straight reinforcement bar RENFORT17 (Suitable for angled installation)



Why not add a Kinmoon tray to the Supra Solo see page 10 for details



Supra Solo – chrome profile – transparent glass

Dimensions

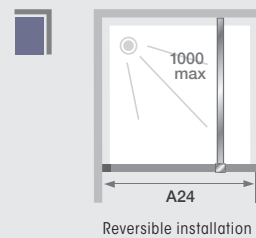

All measurements in mm

Colours



Chrome



White

Installation



Walk-in

Features

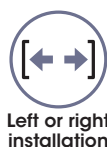



Supra Solo - white profile - stripe patterned glass - with straight reinforcement bar

Pivot door

Kinestyle is a premium range of enclosures that offers a modern take on the industrial look, with chrome profiles, modern handles and hinges. This pivot door with small fixed panel can open inwards or outwards and is designed for recess installation.

- Chrome effect profile
- 180° inwards/outwards opening door
- Chrome reinforcement bar
- Chrome-plated metal hinges and handles
- Threshold bar included
- Anti-limescale treatment

Product codes and dimensions

Size	Product codes		Dimensions		
	Pivot door-hinges on the left	Pivot door-hinges on the right	A1	A2	A3
700	PA1780CTNEG	PA1780CTNED	675 - 700	60	580
800	PA1781CTNEG	PA1781CTNED	775 - 800	60	680
900	PA1782CTNEG	PA1782CTNED	875 - 900	310	530
1000	PA1783CTNEG	PA1783CTNED	975 - 1000	310	630
1200	PA1784CTNEG	PA1784CTNED	1175 - 1200	510	630
1400	PA1785CTNEG	PA1785CTNED	1375 - 1400	710	630
1600	PA1786CTNEG	PA1786CTNED	1575 - 1600	910	630

Dimensions

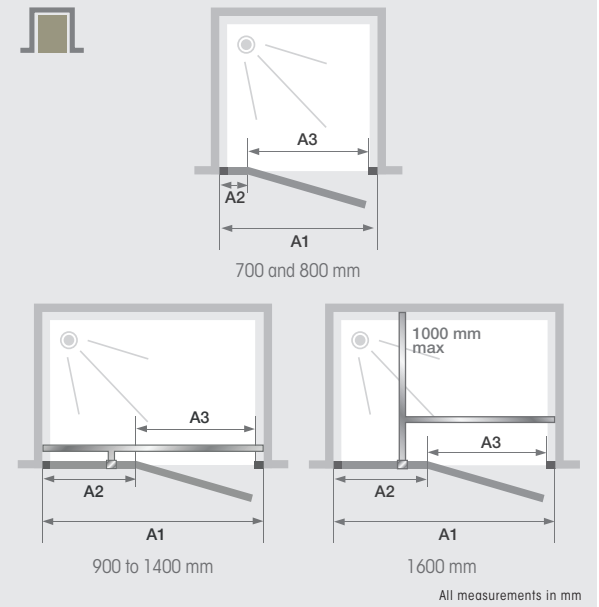

Colours



Chrome

Installation



Pivot door

Features





Kinestyle Pivot door

Sliding door for a recess

Kinestyle is a premium range of enclosures that offers a modern take on the industrial look, with chrome profiles, and visible rollers on our sliding door range. This sliding door is designed for a recess installation.

- Chrome effect profile
- Modern designed industrial look rollers
- Chrome-plated metal handle
- Threshold bar included
- Anti-limescale treatment

Product codes and dimensions

Size	Product codes	Dimensions		
		A4	A5	A6
1000	PA1773CTNE	985 - 1025	470	350
1200	PA1774CTNE	1185 - 1225	570	450
1400	PA1775CTNE	1385 - 1425	670	550
1600	PA1777CTNE	1585 - 1625	770	650
1700	PA1776CTNE	1685 - 1725	820	700

Dimensions

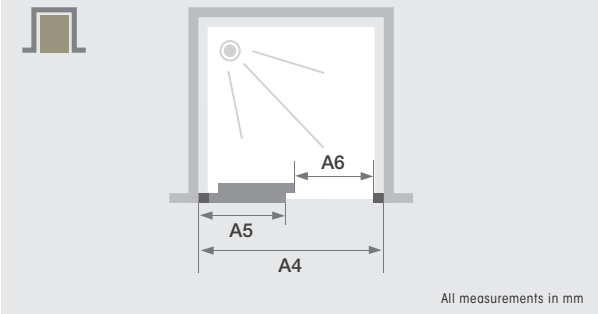

Colours



Chrome

Installation



Sliding door



Why not add a Kineline tray to the Kinestyle see page 18 for details

Features

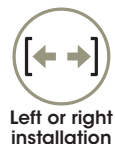



Kinestyle sliding door for recess

Corner entry with 2 sliding doors and fixed panels

Kinestyle is a premium range of enclosures that offers a modern take on the industrial look, with chrome profiles, and visible rollers on our sliding doors. This corner entry option comes with 2 sliding doors.

- Chrome effect profile
- Modern designed industrial look rollers
- Threshold bar included
- Anti-limescale treatment

Product codes and dimensions

Size	Product codes	Dimensions				
		A7	A8	A9	A10	A11
900 x 900	PA1756CTNE	875 - 900	875 - 900	400	400	450
1000 x 800	PA1750CTNE	975 - 1000	775 - 800	450	350	450
1000 x 900	PA1755CTNE	975 - 1000	875 - 900	450	400	510
1200 x 800	PA1751CTNE	1175 - 1200	775 - 800	550	350	530
1200 x 900	PA1752CTNE	1175 - 1200	875 - 900	550	400	590
1400 x 800	PA1753CTNE	1375 - 1400	775 - 800	650	350	620
1400 x 900	PA1754CTNE	1375 - 1400	875 - 900	650	400	670

Dimensions

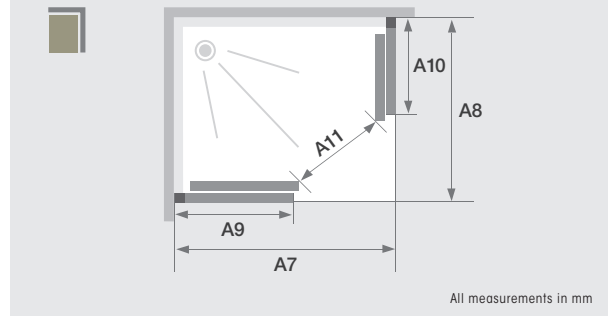

Colours



Chrome

Installation



Sliding corner entry



Why not add Kinewall bathroom wall panels to Kinestyle see page 136 for details

Features





Kinestyle corner entry with 2 sliding doors

Pivot door and fixed side panel

Kinestyle is a premium range of enclosures that offers a modern take on the industrial look, with chrome profiles, modern handles and hinges. This pivot door with small fixed panel can open inwards or outwards and a side fixed panel for a corner installation.

- Chrome effect profile
- 180° inwards/outwards opening door
- Chrome reinforcement bar
- Chrome-plated metal hinges and handles
- Threshold bar included
- Anti-limescale treatment

Product codes and dimensions

Size	Product codes		Dimensions		
	Pivot door-hinges on the left	Pivot door-hinges on the right	A12	A13	A14
700	PA1790CTNEG	PA1790CTNED	670 - 685	60	580
800	PA1791CTNEG	PA1791CTNED	770 - 785	60	680
900	PA1792CTNEG	PA1792CTNED	870 - 885	310	530
1000	PA1793CTNEG	PA1793CTNED	970 - 985	310	630
1200	PA1794CTNEG	PA1794CTNED	1170 - 1185	510	630
1400	PA1795CTNEG	PA1795CTNED	1370 - 1385	710	630
1600	PA1796CTNEG	PA1796CTNED	1570 - 1585	910	630

Size	Product codes	Dimensions
	Fixed panel	A15
700	PA1736CTNE	680 - 695
800	PA1737CTNE	780 - 795
900	PA1738CTNE	880 - 895

Dimensions

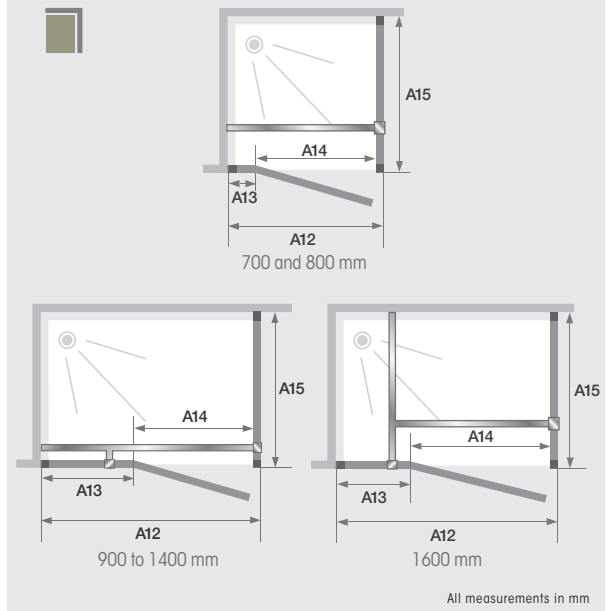

Colours



Chrome

Installation



Pivot door

Features

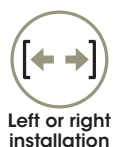



Kinestyle Pivot door and fixed side panel

Sliding door with fixed side panel

Kinestyle is a premium range of enclosures that offers a modern take on the industrial look, with chrome profiles, and visible rollers on our sliding door range. This sliding door comes with a fixed side panel and is designed for a corner installation.

- Chrome effect profile
- Modern designed industrial look rollers
- Chrome-plated metal handle
- Threshold bar included
- Anti-limescale treatment

Product codes and dimensions

Size	Product codes	Dimensions			
		A16	A17	A18	Fixed panel A19
1000 x 700	PA1810CTNE	975 - 1000	470	380	675 - 700
1000 x 800	PA1710CTNE	975 - 1000	470	380	775 - 800
1000 x 900	PA1811CTNE	975 - 1000	470	380	875 - 900
1000 x 1000	PA1812CTNE	975 - 1000	470	380	975 - 1000
1200 x 700	PA1813CTNE	1175 - 1200	570	480	675 - 700
1200 x 800	PA1711CTNE	1175 - 1200	570	480	775 - 800
1200 x 900	PA1712CTNE	1175 - 1200	570	480	875 - 900
1200 x 1000	PA1814CTNE	1175 - 1200	570	480	975 - 1000
1400 x 700	PA1815CTNE	1375 - 1400	670	580	675 - 700
1400 x 800	PA1713CTNE	1375 - 1400	670	580	775 - 800
1400 x 900	PA1714CTNE	1375 - 1400	670	580	875 - 900
1400 x 1000	PA1816CTNE	1375 - 1400	670	580	975 - 1000
1600 x 700	PA1817CTNE	1575 - 1600	770	680	675 - 700
1600 x 800	PA1818CTNE	1575 - 1600	770	680	775 - 800
1600 x 900	PA1819CTNE	1575 - 1600	770	680	875 - 900
1600 x 1000	PA1820CTNE	1575 - 1600	770	680	975 - 1000
1700 x 700	PA1716CTNE	1675 - 1700	820	730	675 - 700
1700 x 800	PA1715CTNE	1675 - 1700	820	730	775 - 800
1700 x 900	PA1717CTNE	1675 - 1700	820	730	875 - 900
1700 x 1000	PA1718CTNE	1675 - 1700	820	730	975 - 1000

Dimensions

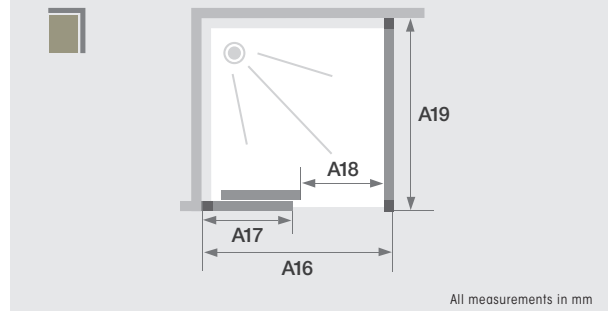

Colours



Chrome

Installation



Sliding door

Features





Kinestyle sliding door with fixed side panel

Pivot door for recess

The Smart Design range offers an innovative design for easy installation but with slim profiles, slender handles and no visible screws it is also sleek and modern in design. The pivot door version for recess opens inwards or outwards and larger sizes have a small fixed panel and pivot door.

- Aluminium profile available in white, chrome or black finish
- Doors over 1000mm are supplied with stainless steel reinforcement bars in chrome, white or black finish
- Pivot profile allows total opening of 180° either inwards or outwards
- Optional threshold bar included
- Panels are reversible
- Enclosures over 1000mm come with fixed panel and pivot door
- Anti-limescale treatment



Pivot door for recess 1100mm - white profile - cosmos glass

Product codes and dimensions

Size	Product codes			Dimensions		
	White profile	Chrome profile	Black profile	G8	G9	G10
	Transparent glass	Transparent glass	Transparent glass			
700	PA9040BTNE	PA9040CTNE	PA9040NTNE	670 - 700	-	570
750	PA9041BTNE	PA9041CTNE	PA9041NTNE	720 - 750	-	620
800	PA9042BTNE	PA9042CTNE	PA9042NTNE	770 - 800	-	670
850	PA9043BTNE	PA9043CTNE	PA9043NTNE	820 - 850	-	720
900	PA9044BTNE	PA9044CTNE	PA9044NTNE	870 - 900	-	770
950	PA9045BTNE	PA9045CTNE	PA9045NTNE	920 - 950	-	820
1000	PA9046BTNE	PA9046CTNE	PA9046NTNE	970 - 1000	-	870
1100	PA9050BTNE	PA9050CTNE	PA9050NTNE	1070 - 1100	346	670
1200	PA9051BTNE	PA9051CTNE	PA9051NTNE	1170 - 1200	446	670
1300	PA9052BTNE	PA9052CTNE	PA9052NTNE	1270 - 1300	446	770
1400	PA9053BTNE	PA9053CTNE	PA9053NTNE	1370 - 1400	546	770
1500	PA9054BTNE	PA9054CTNE	PA9054NTNE	1470 - 1500	646	770
1600	PA9055BTNE	PA9055CTNE	PA9055NTNE	1570 - 1600	746	770
1700	PA9056BTNE	PA9056CTNE	PA9056NTNE	1670 - 1700	846	770
1800	PA9057BTNE	PA9057CTNE	PA9057NTNE	1770 - 1800	946	770

Dimensions

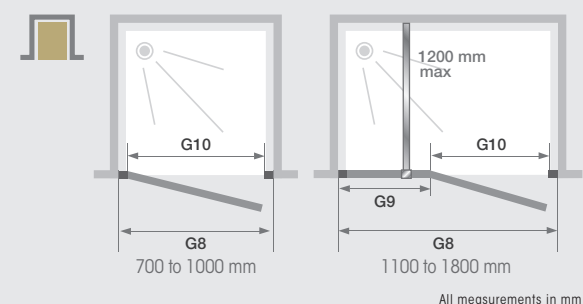

Colours

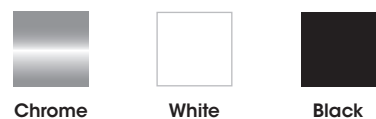

Installation

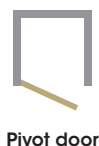

Features

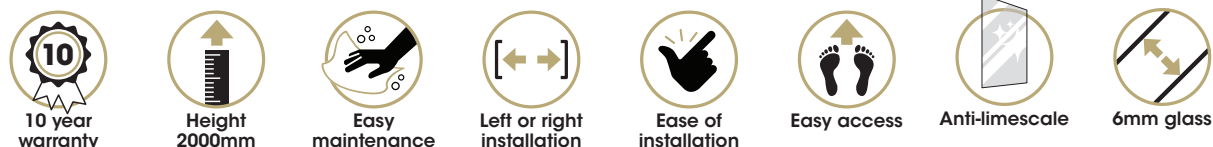



Smart Design pivot door for recess

Pivot door with side panel

The Smart Design range offers an innovative design for easy installation but with slim profiles, slender handles and no visible screws it is also sleek and modern in design. The pivot door open inwards or outwards and larger sizes have a small fixed panel and pivot door this version comes with a side panel for corner installation.

- Aluminium profile available in white, chrome, or black finish
- Pivot doors allow full opening inwards and outwards to 180°
- Optional threshold bar included
- Reinforcement bar in chrome stainless steel (for panel with white or chrome profiles) or in black stainless steel (for panel with black profile)
- Reversible panels
- Anti-limescale treatment



Pivot door with side panel for larger sizes

Product codes and dimensions

Size	Product codes			Dimensions				
	Door			G17	G19	G20		
	White profile	Chrome profile	Black profile					
	Transparent glass	Transparent glass	Transparent glass					
700 to 1000 mm	700	PA90170BTNE	PA90170CTNE	PA90170NTNE	670 - 685	-	585	
	750	PA90171BTNE	PA90171CTNE	PA90171NTNE	720 - 735	-	635	
	800	PA90172BTNE	PA90172CTNE	PA90172NTNE	770 - 785	-	685	
	850	PA90173BTNE	PA90173CTNE	PA90173NTNE	820 - 835	-	735	
	900	PA90174BTNE	PA90174CTNE	PA90174NTNE	870 - 885	-	785	
	950	PA90175BTNE	PA90175CTNE	PA90175NTNE	920 - 935	-	835	
	1000	PA90176BTNE	PA90176CTNE	PA90176NTNE	970 - 985	-	885	
	1100 to 1800 mm	1100	PA90180BTNE	PA90180CTNE	PA90180NTNE	1070 - 1085	345	685
		1200	PA90181BTNE	PA90181CTNE	PA90181NTNE	1170 - 1185	445	685
		1300	PA90182BTNE	PA90182CTNE	PA90182NTNE	1270 - 1285	445	785
1400		PA90183BTNE	PA90183CTNE	PA90183NTNE	1370 - 1385	545	785	
1500		PA90184BTNE	PA90184CTNE	PA90184NTNE	1470 - 1485	645	785	
1600		PA90185BTNE	PA90185CTNE	PA90185NTNE	1570 - 1585	745	785	
1700		PA90186BTNE	PA90186CTNE	PA90186NTNE	1670 - 1685	845	785	
1800		PA90187BTNE	PA90187CTNE	PA90187NTNE	1770 - 1785	945	785	

Size	Product codes			Dimensions
	Side panel			G18
	White profile	Chrome profile	Black profile	
	Transparent glass	Transparent glass	Transparent glass	
700	PA90150BTNE	PA90150CTNE	PA90150NTNE	670 - 685
750	PA90151BTNE	PA90151CTNE	PA90151NTNE	720 - 735
800	PA90152BTNE	PA90152CTNE	PA90152NTNE	770 - 785
850	PA90153BTNE	PA90153CTNE	PA90153NTNE	820 - 835
900	PA90154BTNE	PA90154CTNE	PA90154NTNE	870 - 885
950	PA90155BTNE	PA90155CTNE	PA90155NTNE	920 - 935
1000	PA90156BTNE	PA90156CTNE	PA90156NTNE	970 - 985
1100	PA90157BTNE	PA90157CTNE	PA90157NTNE	1070 - 1085
1200	PA90158BTNE	PA90158CTNE	PA90158NTNE	1170 - 1185

Dimensions

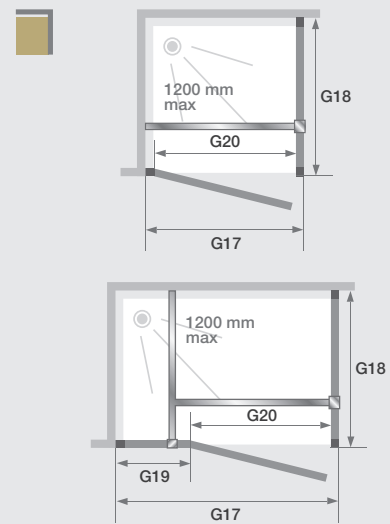

All measurements in mm

Colours

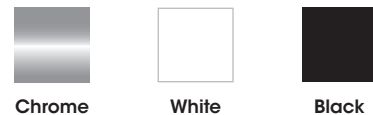

Installation



Pivot door

Features





Smart Design pivot door with side panel – black profile

Two saloon doors

The Smart Design range offers an innovative design for easy installation but with slim profiles, slender handles and no visible screws it is also sleek and modern in design. Two saloon doors open inwards or outwards, perfect for a smaller bathroom but still allowing maximum entry into the shower.

- Doors open either inwards or outwards 180°
- Optional threshold bar included
- Aluminium profile available in white, chrome or black finish
- Anti-limescale treatment

Product codes and dimensions

Size	Product codes			Dimensions		
	White profile	Chrome profile	Black profile	G11	G12	G13
	Transparent glass	Transparent glass	Transparent glass			
700	PA9070BTNE	PA9070CTNE	PA9070NTNE	670 - 700	540	298
750	PA9071BTNE	PA9071CTNE	PA9071NTNE	720 - 750	590	323
800	PA9072BTNE	PA9072CTNE	PA9072NTNE	770 - 800	640	348
850	PA9073BTNE	PA9073CTNE	PA9073NTNE	820 - 850	690	373
900	PA9074BTNE	PA9074CTNE	PA9074NTNE	870 - 900	740	398
950	PA9075BTNE	PA9075CTNE	PA9075NTNE	920 - 950	790	423
1000	PA9076BTNE	PA9076CTNE	PA9076NTNE	970 - 1000	840	448
1100	PA9077BTNE	PA9077CTNE	PA9077NTNE	1070 - 1100	940	498
1200	PA9078BTNE	PA9078CTNE	PA9078NTNE	1170 - 1200	1040	548

Dimensions

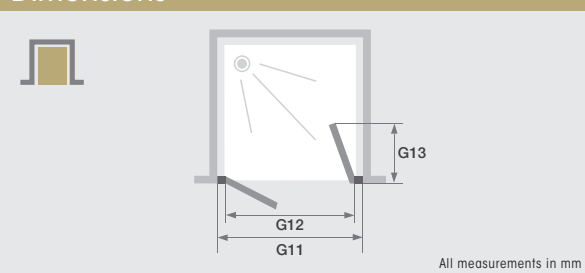

Colours

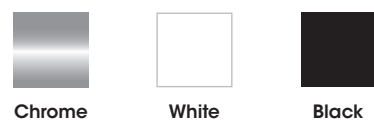

Installation



Saloon door



Why not add Kinewall bathroom wall panels to Smart Design see page 136 for details

Features





Enclosures

Smart Design - Two saloon doors

Bi-fold door with fixed side panel

The Smart Design range offers an innovative design for easy installation but with slim profiles, slender handles and no visible screws it is also sleek and modern in design. The Bi-fold door folds inwards or outwards to create a large opening space and with fixed side panel it is designed for a corner installation.

- Aluminium profile available in white or chrome finish
- Pivot profiles mean the door can open 180° inwards or outwards
- Optional threshold bar included
- Reinforcement bar in chrome effect (1200mm maximum)
- Easy closing; metal hinges with stepped indexing, that match the profile colour chosen
- Reversible panels
- Anti-limescale treatment



Product codes and dimensions

Size	Product codes		Dimensions		
	Door		G21	G23	G24
	White profile Transparent glass	Chrome profile Transparent glass			
700	PA90190BTNE	PA90190CTNE	670 - 685	545	325
750	PA90191BTNE	PA90191CTNE	720 - 735	595	350
800	PA90192BTNE	PA90192CTNE	770 - 785	645	375
850	PA90193BTNE	PA90193CTNE	820 - 835	695	400
900	PA90194BTNE	PA90194CTNE	870 - 885	745	425
950	PA90195BTNE	PA90195CTNE	920 - 935	795	450
1000	PA90196BTNE	PA90196CTNE	970 - 985	845	475

Size	Product codes		Dimensions
	Fixed panel		G22
	White profile Transparent glass	Chrome profile Transparent glass	
700	PA90150BTNE	PA90150CTNE	670 - 685
750	PA90151BTNE	PA90151CTNE	720 - 735
800	PA90152BTNE	PA90152CTNE	770 - 785
850	PA90153BTNE	PA90153CTNE	820 - 835
900	PA90154BTNE	PA90154CTNE	870 - 885
950	PA90155BTNE	PA90155CTNE	920 - 935
1000	PA90156BTNE	PA90156CTNE	970 - 985
1100	PA90157BTNE	PA90157CTNE	1070 - 1085
1200	PA90158BTNE	PA90158CTNE	1170 - 1185

Dimensions

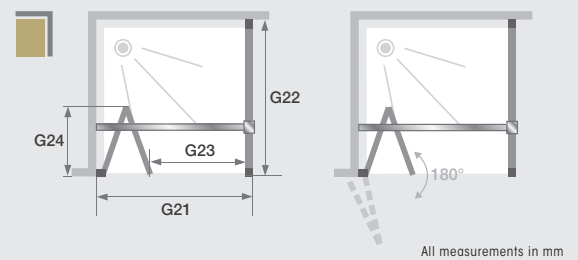

Colours



Chrome



White

Installation



Bi-fold door

Features





Smart Design bi-fold door with side panel

Sliding door for recess

The Smart Design range offers innovative design for easy installation with a sleek modern look. This sliding door is designed for a recess installation and with rollers that unclip at the bottom and no overlap between the door and fixed panel cleaning is easy.

- Aluminium profile available in white, chrome, or black finish
- Easy cleaning: The door and fixed panel do not overlap, plus the bottom of the door can be unclipped if necessary
- Optional threshold bar included
- Fixed panel can be on left or right - unit is not reversible so please ensure correct code is chosen
- Comes with rollers already fitted for easy installation
- Anti-limescale treatment

Product codes and dimensions

Size	Product codes			Dimensions		
	Fixed panel on the left, opening on the right					
	White profile	Chrome profile	Black profile	G14	G15	G16
	Transparent glass	Transparent glass	Transparent glass			
900	PA90110BTNEG	PA90110CTNEG	PA90110NTNEG	870 - 900	408	345
950	PA90111BTNEG	PA90111CTNEG	PA90111NTNEG	920 - 950	433	370
1000	PA90112BTNEG	PA90112CTNEG	PA90112NTNEG	970 - 1000	458	395
1100	PA90113BTNEG	PA90113CTNEG	PA90113NTNEG	1070 - 1100	508	445
1200	PA90114BTNEG	PA90114CTNEG	PA90114NTNEG	1170 - 1200	558	495
1300	PA90120BTNEG	PA90120CTNEG	PA90120NTNEG	1270 - 1300	608	545
1400	PA90121BTNEG	PA90121CTNEG	PA90121NTNEG	1370 - 1400	658	595
1500	PA90122BTNEG	PA90122CTNEG	PA90122NTNEG	1470 - 1500	708	645
1600	PA90123BTNEG	PA90123CTNEG	PA90123NTNEG	1570 - 1600	758	695
1700	PA90124BTNEG	PA90124CTNEG	PA90124NTNEG	1670 - 1700	808	745
1800	PA90125BTNEG	PA90125CTNEG	PA90125NTNEG	1770 - 1800	858	795

Size	Product codes			Dimensions		
	Fixed panel on the right, opening on the left					
	White profile	Chrome profile	Black profile	G14	G15	G16
	Transparent glass	Transparent glass	Transparent glass			
900	PA90110BTNED	PA90110CTNED	PA90110NTNED	870 - 900	408	345
950	PA90111BTNED	PA90111CTNED	PA90111NTNED	920 - 950	433	370
1000	PA90112BTNED	PA90112CTNED	PA90112NTNED	970 - 1000	458	395
1100	PA90113BTNED	PA90113CTNED	PA90113NTNED	1070 - 1100	508	445
1200	PA90114BTNED	PA90114CTNED	PA90114NTNED	1170 - 1200	558	495
1300	PA90120BTNED	PA90120CTNED	PA90120NTNED	1270 - 1300	608	545
1400	PA90121BTNED	PA90121CTNED	PA90121NTNED	1370 - 1400	658	595
1500	PA90122BTNED	PA90122CTNED	PA90122NTNED	1470 - 1500	708	645
1600	PA90123BTNED	PA90123CTNED	PA90123NTNED	1570 - 1600	758	695
1700	PA90124BTNED	PA90124CTNED	PA90124NTNED	1670 - 1700	808	745
1800	PA90125BTNED	PA90125CTNED	PA90125NTNED	1770 - 1800	858	795

Features



10 year warranty



Height 2000mm



Easy maintenance



Left or right installation



Ease of installation



Easy access



Anti-limescale



6mm glass



Dimensions

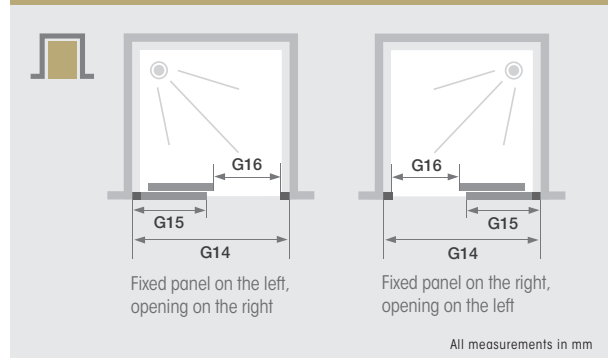

Colours

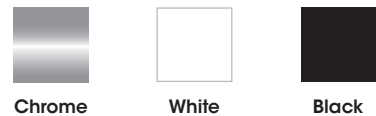

Installation





Smart Design sliding door for recess

Sliding door and fixed side panel

The Smart Design range offers innovative design for easy installation with a sleek modern look. This sliding door comes with a side panel for corner installation and with rollers that unclip at the bottom and no overlap between the door and fixed panel cleaning is easy.

- Aluminium profile available in white, chrome or black finish
- Easy cleaning: The door and fixed panel do not overlap, plus the bottom of the door can be unclipped if necessary
- Optional threshold bar included
- Comes with rollers already fitted for easy installation
- Anti-limescale treatment

Product codes and dimensions

Size	Product codes			Dimensions		
	Door - Fixed panel on the left, opening on the right					
	White profile	Chrome profile	Black profile	G25	G27	G28
	Transparent glass	Transparent glass	Transparent glass			
900	PA90110BTNEG	PA90110CTNEG	PA90110NTNEG	870 - 885	408	345
950	PA90111BTNEG	PA90111CTNEG	PA90111NTNEG	920 - 935	433	370
1000	PA90112BTNEG	PA90112CTNEG	PA90112NTNEG	970 - 985	458	395
1100	PA90113BTNEG	PA90113CTNEG	PA90113NTNEG	1070 - 1085	508	445
1200	PA90114BTNEG	PA90114CTNEG	PA90114NTNEG	1170 - 1185	558	495
1300	PA90120BTNEG	PA90120CTNEG	PA90120NTNEG	1270 - 1285	608	545
1400	PA90121BTNEG	PA90121CTNEG	PA90121NTNEG	1370 - 1385	658	595
1500	PA90122BTNEG	PA90122CTNEG	PA90122NTNEG	1470 - 1485	708	645
1600	PA90123BTNEG	PA90123CTNEG	PA90123NTNEG	1570 - 1585	758	695
1700	PA90124BTNEG	PA90124CTNEG	PA90124NTNEG	1670 - 1685	808	745
1800	PA90125BTNEG	PA90125CTNEG	PA90125NTNEG	1770 - 1785	858	795

Size	Product codes			Dimensions		
	Door - Fixed panel on the right, opening on the left					
	White profile	Chrome profile	Black profile	G25	G27	G28
	Transparent glass	Transparent glass	Transparent glass			
900	PA90110BTNED	PA90110CTNED	PA90110NTNED	870 - 885	408	345
950	PA90111BTNED	PA90111CTNED	PA90111NTNED	920 - 935	433	370
1000	PA90112BTNED	PA90112CTNED	PA90112NTNED	970 - 985	458	395
1100	PA90113BTNED	PA90113CTNED	PA90113NTNED	1070 - 1085	508	445
1200	PA90114BTNED	PA90114CTNED	PA90114NTNED	1170 - 1185	558	495
1300	PA90120BTNED	PA90120CTNED	PA90120NTNED	1270 - 1285	608	545
1400	PA90121BTNED	PA90121CTNED	PA90121NTNED	1370 - 1385	658	595
1500	PA90122BTNED	PA90122CTNED	PA90122NTNED	1470 - 1485	708	645
1600	PA90123BTNED	PA90123CTNED	PA90123NTNED	1570 - 1585	758	695
1700	PA90124BTNED	PA90124CTNED	PA90124NTNED	1670 - 1685	808	745
1800	PA90125BTNED	PA90125CTNED	PA90125NTNED	1770 - 1785	858	795

	Fixed panel			G26
	White profile	Chrome profile	Black profile	
	Transparent glass	Transparent glass	Transparent glass	
700	PA90290BTNE	PA90290CTNE	PA90290NTNE	670 - 685
750	PA90291BTNE	PA90291CTNE	PA90291NTNE	720 - 735
800	PA90292BTNE	PA90292CTNE	PA90292NTNE	770 - 785
850	PA90293BTNE	PA90293CTNE	PA90293NTNE	820 - 835
900	PA90294BTNE	PA90294CTNE	PA90294NTNE	870 - 885
950	PA90295BTNE	PA90295CTNE	PA90295NTNE	920 - 935
1000	PA90296BTNE	PA90296CTNE	PA90296NTNE	970 - 985
1100	PA90297BTNE	PA90297CTNE	PA90297NTNE	1070 - 1085
1200	PA90298BTNE	PA90298CTNE	PA90298NTNE	1170 - 1185

Dimensions

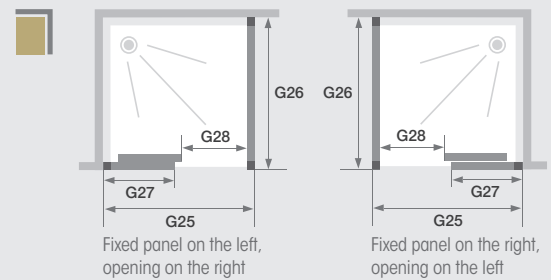

All measurements in mm

Colours

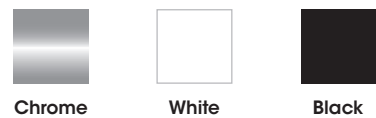

Chrome

White

Black

Installation



Sliding door

Features





Smart Design sliding door with fixed side panel

Corner entry with two sliding doors

The Smart Design range offers innovative design for easy installation with a sleek modern look. This corner entry version comes with two sliding doors and with rollers that unclip at the bottom and no overlap between the door and fixed panel cleaning is easy to keep it looking as good as the day it was installed.

- Aluminium profile available in white, chrome or black finish
- Easy cleaning: The door and fixed panel do not overlap, plus the bottom of the door can be unclipped if necessary
- Optional threshold bar included
- Each side must be ordered separately as you can tailor this unit for different sized sides
- Comes with rollers already fitted for easy installation
- Anti-limescale treatment

Product codes and dimensions

Size	Product codes			Dimensions		
	Fixed panel on the left, opening on the right					
	White profile	Chrome profile	Black profile	G29	G30	G31
	Transparent glass	Transparent glass	Transparent glass			
700	PA90160BTNEG	PA90160CTNEG	PA90160NTNEG	670 - 685	300	337
750	PA90161BTNEG	PA90161CTNEG	PA90161NTNEG	720 - 735	325	372
800	PA90162BTNEG	PA90162CTNEG	PA90162NTNEG	770 - 785	350	408
850	PA90163BTNEG	PA90163CTNEG	PA90163NTNEG	820 - 835	375	443
900	PA90164BTNEG	PA90164CTNEG	PA90164NTNEG	870 - 885	400	478
950	PA90165BTNEG	PA90165CTNEG	PA90165NTNEG	920 - 935	425	514
1000	PA90166BTNEG	PA90166CTNEG	PA90166NTNEG	970 - 985	450	549
1100	PA90167BTNEG	PA90167CTNEG	PA90167NTNEG	1070 - 1085	500	620*
1200	PA90168BTNEG	PA90168CTNEG	PA90168NTNEG	1170 - 1185	550	690*

Size	Product codes			Dimensions		
	Fixed panel on the right, opening on the left					
	White profile	Chrome profile	Black profile	G29	G30	G31
	Transparent glass	Transparent glass	Transparent glass			
700	PA90160BTNED	PA90160CTNED	PA90160NTNED	670 - 685	300	337
750	PA90161BTNED	PA90161CTNED	PA90161NTNED	720 - 735	325	372
800	PA90162BTNED	PA90162CTNED	PA90162NTNED	770 - 785	350	408
850	PA90163BTNED	PA90163CTNED	PA90163NTNED	820 - 835	375	443
900	PA90164BTNED	PA90164CTNED	PA90164NTNED	870 - 885	400	478
950	PA90165BTNED	PA90165CTNED	PA90165NTNED	920 - 935	425	514
1000	PA90166BTNED	PA90166CTNED	PA90166NTNED	970 - 985	450	549
1100	PA90167BTNED	PA90167CTNED	PA90167NTNED	1070 - 1085	500	620*
1200	PA90168BTNED	PA90168CTNED	PA90168NTNED	1170 - 1185	550	690*

* Width of opening with a second 1000 mm wide door

Features



10 year warranty



Height 2000mm



Easy maintenance



Left or right installation



Ease of installation



Easy access



Anti-limescale



6mm glass

Dimensions

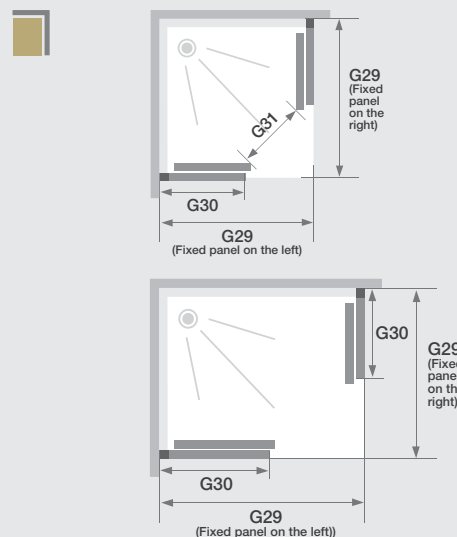

All measurements in mm

Colours

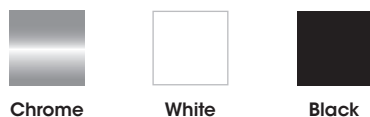

Installation



Corner entry sliding door



Smart Design corner entry with two sliding doors

Quadrant with pivot doors

The Smart Design range offers an innovative design for easy installation but with slim profiles, slender handles and no visible screws it is also sleek and modern in design. This quadrant comes with two pivot doors that can open inwards or outwards so a great solution for a smaller bathroom.

- Aluminium profile available in white or chrome finish
- Pivot profiles allow the doors to open to 180° either inwards or outwards
- Chrome reinforcement brackets
- Optional threshold bar included
- Anti-limescale treatment

Product codes and dimensions

Size	Product codes		Dimensions		
	White profile Transparent glass	Chrome profile Transparent glass	G32	G33	G34
900	PA90198BTNE	PA90198CTNE	870/885	232	846
1000	PA90199BTNE	PA90199CTNE	970/985	332	846

Dimensions

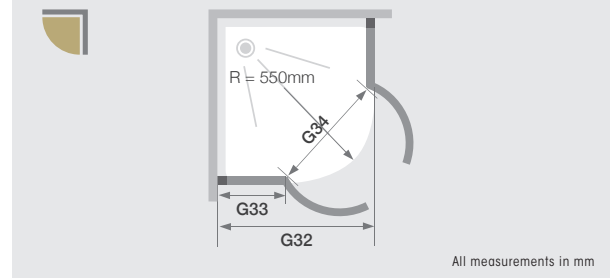

Colours



Chrome



White

Installation



Quadrant pivot door

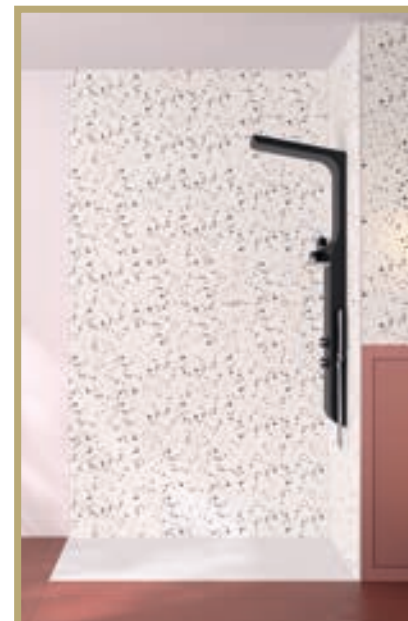

Why not add Kinewall bathroom wall panels to Smart Design see page 136 for details

Features



10 year warranty



Height 2000mm



Easy maintenance



Left or right installation



Ease of installation



Easy access



Anti-limescale



6mm glass



Smart Design quadrant with pivot doors

Quadrant with sliding doors

The Smart Design range offers an innovative design for easy installation but with slim profiles, slender handles and no visible screws it is also sleek and modern in design. This quadrant comes with two sliding doors and with rollers that unclip at the bottom and no overlap between the door and fixed panel cleaning is easy to keep it looking as good as the day it was installed.

- Aluminium profile available in white or chrome finish
- Easy to install with quick assembly, pre-mounted rollers
- Easy cleaning: The door and fixed panel do not overlap, plus the bottom of the door can be unclipped if necessary
- Comes with rollers already fitted for easy installation
- Anti-limescale treatment

Product codes and dimensions

Size	Product codes		Dimensions		
	White profile Transparent glass	Chrome profile Transparent glass	G35	G36	G37
900	PA90280BTNE	PA90280CTNE	870/885	334	520
1000	PA90281BTNE	PA90281CTNE	970/985	434	520

Dimensions

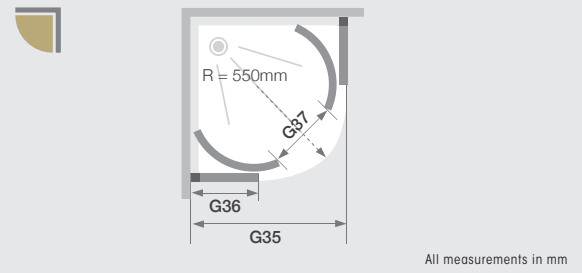

Colours



Chrome



White

Installation



Quadrant sliding door



Why not add Kinewall bathroom wall panels to Smart Design see page 136 for details

Features





Smart Design quadrant with 2 sliding doors



Cubicles

CONTENTS

BROOKLYN	88 - 91
EDEN	92 - 95
HORIZON	96 - 99
MOONLIGHT	100 - 101
KINEPRIME GLASS	102 - 105
KINEPRIME CONTRACT	106 - 107
CONSORT	108 - 109
BREHAT FAST	110 - 111
KINEMAGIC DESIGN	112 - 115
KINEMAGIC SERENITY	116 - 119



Silicone free

In the humid environment of the bathroom, silicone will deteriorate and discolour without constant maintenance. With Kinedo cubicles silicone is redundant – the wall panels of the product are cleverly designed to fit snugly within the shower tray.



No leaks

The precision involved with each cubicle's design allows water to simply run down the inside of the shower with no chance of escape. And as there is no need for tiling or grouting, your shower will stay looking as pristine as the day it was installed.

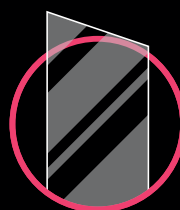

Anti-limescale

Most Kinedo cubicles are treated with a permanent, anti-limescale coating that minimises the build-up of calcium deposits and dirt on glass, reducing the need to clean. This transparent chemical treatment is resistant to hot water and UV rays, encouraging water to run off the glass without leaving streaks or water marks.



10 year warranty

Every one of our cubicles comes with a warranty* of up to 10 years, fully backed by SFA Saniflo UK Ltd.

* For full warranty details, please visit kinedo.co.uk

Brooklyn

The Brooklyn cubicle range has been designed to bring the industrial trend to life. Available in two options: the first creates the full industrial look with black profile and black lines on the glass, the second gives a modern twist with our grey profile and chrome shower.

Its clever design and quality fixtures mean assembly is quick and simple, without silicone and predominately without screws. This robust cubicle comes with pivot or sliding door, white Biocryl shower tray with chrome waste, metal handles and your choice of profile colour, shower and glass, so you can create the perfect look for your bathroom.

- Available in pivot door or sliding door
- White tray is 80mm and comes with chrome waste cover
- Cubicle is 2160mm high
- Back and side panels are white glass
- Quality metal handles and hinges
- Reversible panels for left or right installation
- Comes with shelf for storage
- Sliding doors have unclippable bottom rollers for easy cleaning
- Quick and easy to install with no silicone and no screws (except for wall mounting and accessories)

The Brooklyn cubicle comes with modern grey profiles with chrome shower, including thermostatic mixer valve, hand shower with anti-twist hose and overhead rain shower. This cubicle has transparent glass, its white tray has a chrome waste cover and the handles and hinges are metal. It comes with a storage shelf.

The Brooklyn Factory cubicle comes with modern black profiles with black shower, including thermostatic mixer valve, hand shower with two different spray patterns and anti-twist hose and overhead rain shower with two separate spray patterns. This cubicle has transparent glass with black silk-screen printed lines on the glass, its white tray has a chrome waste cover and the handles are black. It comes with a storage shelf.

*Quadrant comes only as Brooklyn cubicle in the grey and not as Brooklyn factory.



Brooklyn Quadrant 900x900

Installation



Sliding door



Pivot door



Corner



Quadrant*

Fit your space

	900	1100	1200	1600	1700		900
800		Sliding door		Sliding door	Sliding door		900
900	Sliding door		Sliding door				Sliding door

 Sliding door
 Pivot door

All measurements in mm

Colours



Modern Grey



Black

Features



10 year warranty



Height 2160mm



Easy maintenance

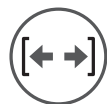

Left or right installation



Ease of installation



Anti-limescale



Shower included



Silicone free



Glass 6mm panels
8mm door



WALL
GLASS
PANELS

Brooklyn Factory 1200x900 sliding door

Cubicles

Product codes

Size	Brooklyn ■ //	Brooklyn ■ /	Brooklyn ■ //	Brooklyn Factory ■ //	Brooklyn Factory ■ /
900 x 900	CA250GTNE	CA260GTNE	CA270GTNE	CA250N2BHE	CA260N2BHE
1100 x 800	CA240GTNE	-	-	CA240N2BHE	-
1200 x 900	CA241GTNE	-	-	CA240N2BHE	-
1600 x 800	CA242GTNE	-	-	CA240N2BHE	-
1700 x 800	CA243GTNE	-	-	CA243N2BHE	-



Brooklyn Factory 900x900 pivot door



Brooklyn 1700x800 sliding door



Chrome handset



Overhead chrome rain shower

Dimensions

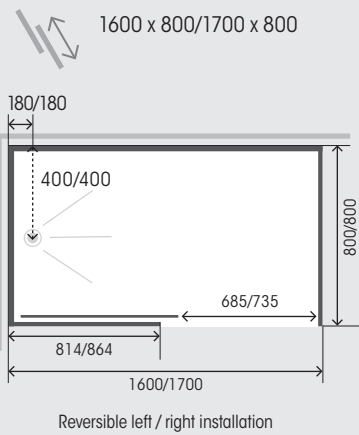
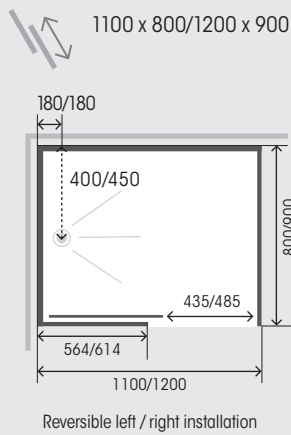
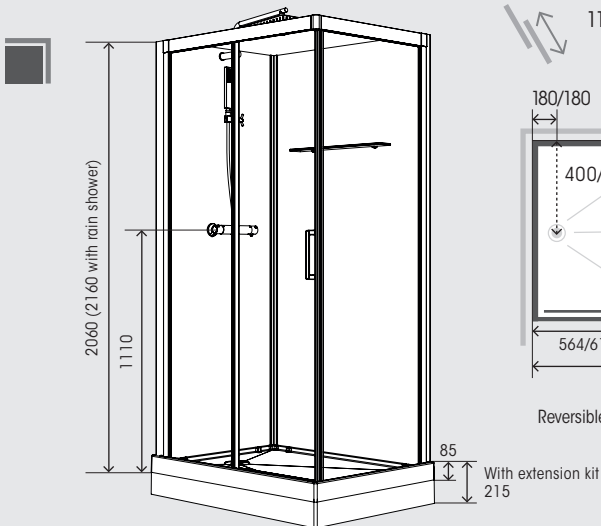
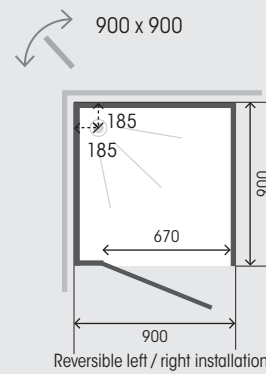
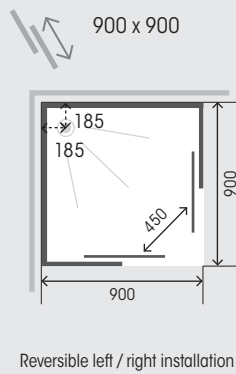
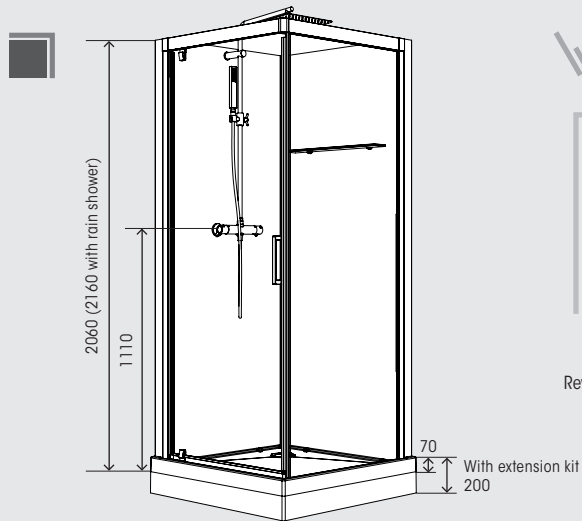
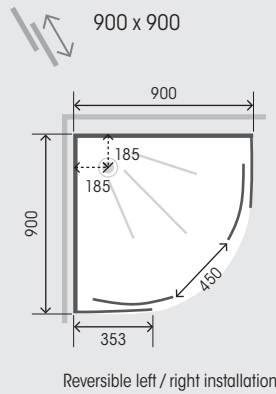
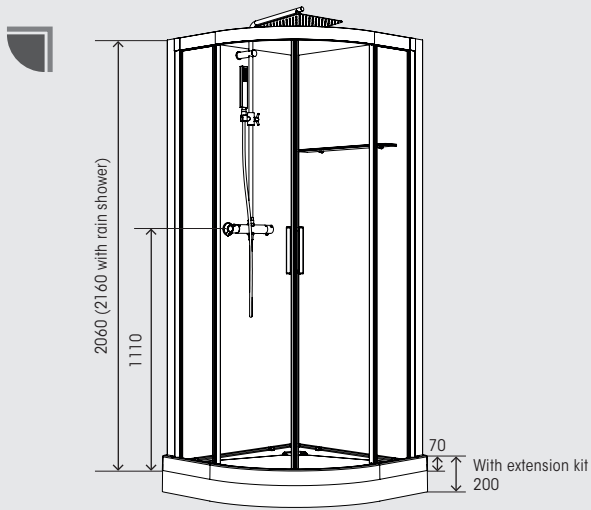

All measurements in mm

Eden

Add an extra bit of luxury to your bathroom with the Eden. It is the perfect solution when space is at a premium.

Elegant glass doors and opaque white glass panels allow you to surround yourself in luxury whilst the polished chrome profiles give the perfect finishing touches for any modern bathroom.

The attractive modern design of the thermostatic shower with built-in glass shelf for shampoo and shower gels means a clutter-free zone that makes best use of the showering space.

- All-in-one shower cubicle
- Chrome profile
- Sliding and pivot doors available
- Thermostatic shower included
- No silicone needed

Colours



Chrome

Installation



Sliding door



Pivot door



Corner



Quadrant

Fit your space

	800	900	1000	1200
800	Sliding door		Sliding door	Sliding door
900		Sliding door		

	800	900
800	Sliding door	
900		Sliding door

Sliding door Pivot door

All measurements in mm



Eden Quadrant 900x900 pivot doors

Features



10 year warranty



Height 2180mm and 2190mm



Easy maintenance

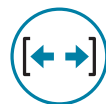

Left or right installation



Ease of installation



Anti-limescale



Shower included



Silicone free



Glass 5mm panels 5mm door







WALL
GLASS
PANELS

Cubicles

Eden 1200x800 sliding doors

Product codes

Size				
800 x 800	CA841	CA851	CA843	CA853
900 x 900	CA842	CA852	CA844	CA854
1000 x 800	CA846	CA856	-	-
1200 x 800	CA847	CA857	-	-



Dimensions

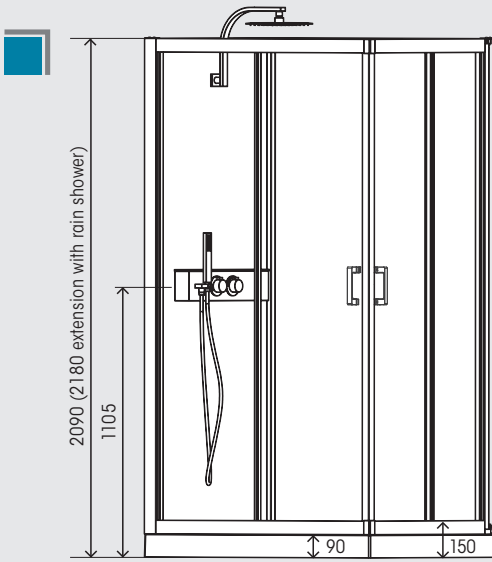

800 x 800/900 x 900

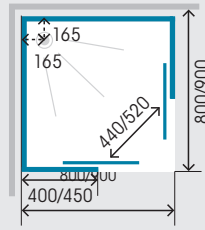

1000 x 800/1200 x 800

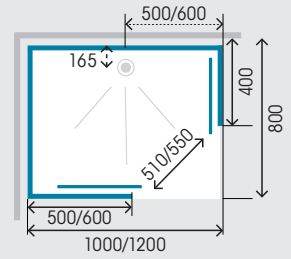

800 x 800/900 x 900

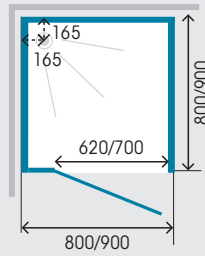

1000 x 800/1200 x 800

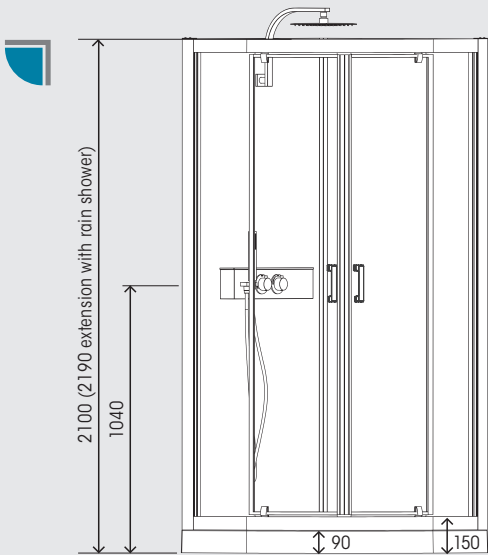
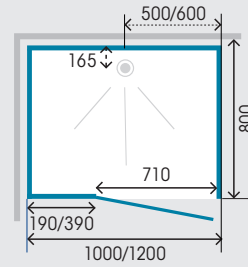

800 x 800/900 x 900

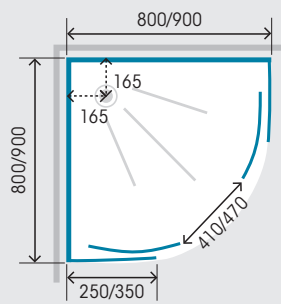

800 x 800/900 x 900

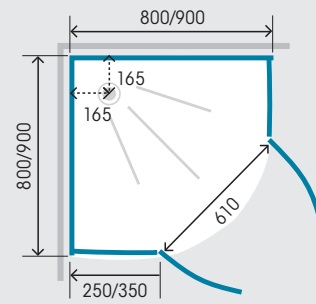

All measurements in mm

Horizon

Adding style and design flair to your home, the classically simple lines of the Horizon cubicle will enhance your bathroom whatever the setting.

High quality 6mm toughened safety glass gives the Horizon an elegant, yet functional all glass design, whilst the integrated shelves and built-in shower controls keep the look contemporary and effortless.

- All-in-one shower cubicle
- Chrome profile
- Sliding and pivot doors available
- Thermostatic shower included
- No silicone needed

Colours



Chrome

Installation



Sliding door



Pivot door



Corner



Quadrant



Recess

Fit your space



Sliding door Pivot door

All measurements in mm



Horizon 1100x800 pivot door

Features



10 year warranty



Height 2215mm



Easy maintenance

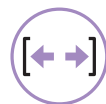

Left or right installation



Ease of installation



Anti-limescale



Shower included



Silicone free







Glass 6mm panels 8mm door



Cubicles

Horizon 1100x800 sliding door

Product codes

Size					
800 x 800	CA136A12	CA116A12	CA131A12	-	-
900 x 900	CA137A12	CA117A12	CA132A12	CA138A12	CA118A12
1100 x 800	CA139A12	CA119A12	-	-	-



Horizon 800x800 recess pivot door



Horizon Quadrant 900x900 pivot doors



Overhead rain shower



Adjustable glass shelves

Dimensions

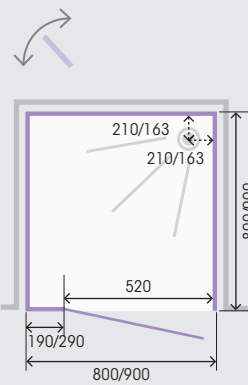
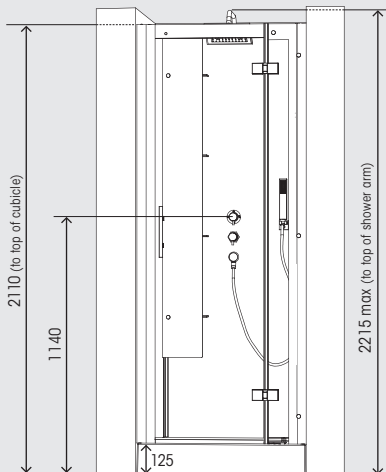
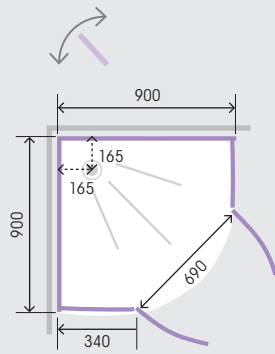
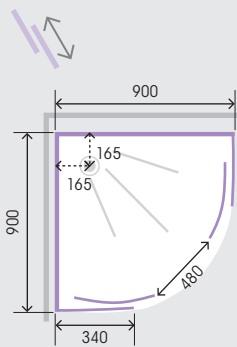
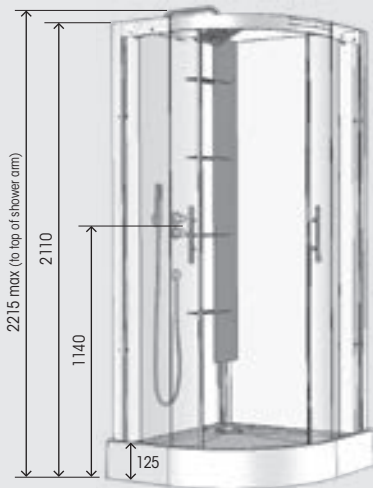
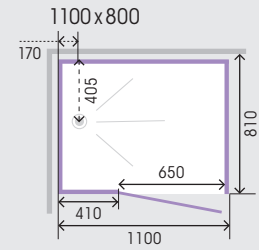
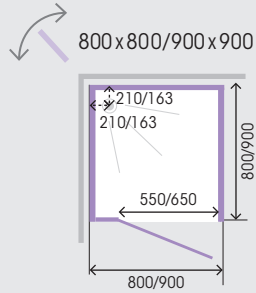
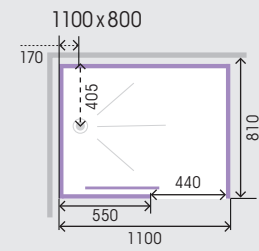
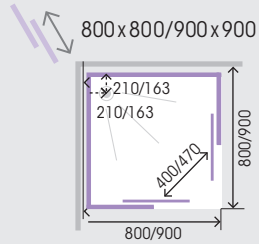
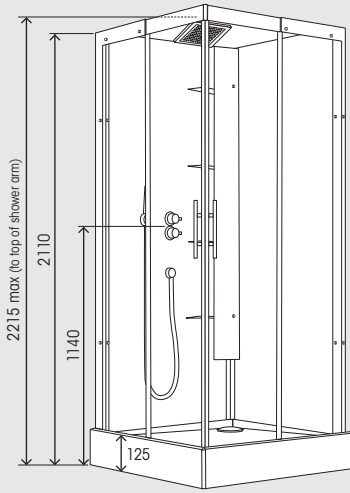

Note: Gap width should be an extra 5mm to allow for recessing the unit

All measurements in mm

Moonlight

With its understated elegance and neutral styling, the Moonlight will blend into any setting, whether classic or contemporary.

Great for those who want the convenience of fitting a shower cubicle but still want the freedom to influence the look of their bathroom, it allows you to accommodate the choice of your own shower control. The brushed aluminium effect panel can be easily drilled for any fixings. Perfect for those who want flexibility as well as great functionality.

- All-in-one shower cubicle
- Chrome profile
- Sliding door
- No shower included in this model
- No silicone needed

Colours



Chrome

Installation



Sliding door



Corner



Quadrant

Fit your space

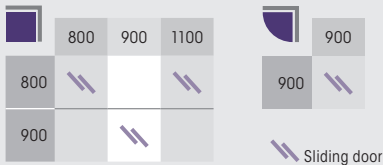

All measurements in mm

Product codes

Size	Corner	Sliding door
800 x 800	CA116A12GB	-
900 x 900	CA117A12GB	CA118A12GB
1100 x 800	CA119A12GB	-

Features

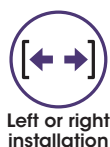

Dimensions

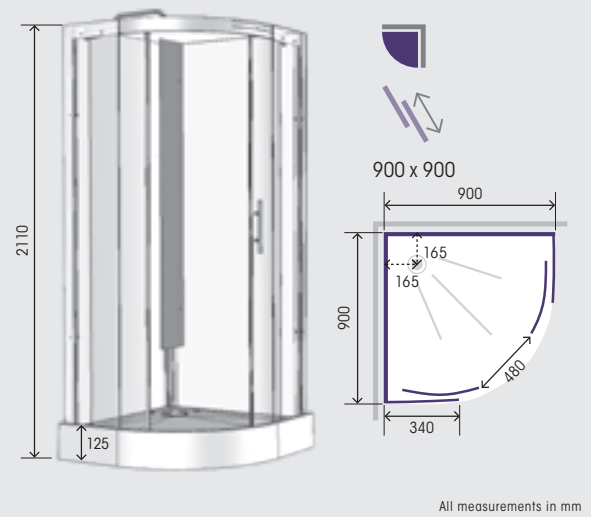
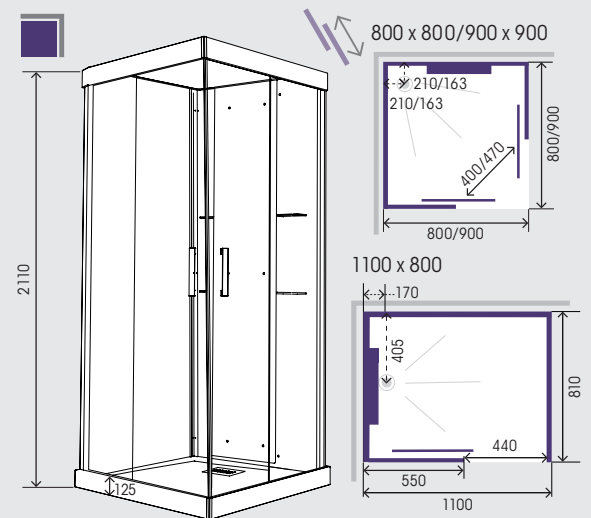

All measurements in mm



WALL
GLASS
PANELS

Cubicles

Moonlight Quadrant 900x900 sliding doors
Shower control shown is not included with Moonlight

Kineprime Glass

Slotting a shower into an un-used space makes sense and the Kineprime Glass is perfect for a recess or a corner and comes in a choice of sizes to suit most situations.

The glass back and side panels make for a quicker solution than tiles and grout and as Kineprime glass comes in both quadrant and corner versions, with a choice of pivot, sliding or saloon doors, this adaptable design can provide a stunning look in the smaller bathroom. Since a thermostatic shower is included, there is nothing else to add.

- All-in-one shower cubicle
- White profile
- Sliding, pivot and saloon doors available
- Thermostatic shower included

Colours



White

Installation



Sliding door



Pivot door



Saloon door



Corner



Quadrant



Recess

Fit your space

	700	800	900	1000		700	800	900	1000		800	900
700	Sliding door				Corner	700				Quadrant	800	
800		Pivot door				800					900	
900			Saloon doors			900						Recess

All measurements in mm

If installing in a recess please check the sizing of the unit as a minimum of 60mm extra is needed for installation purposes. E.g. a 700 cubicle would need a minimum 760mm space.



Kineprime Glass Quadrant 900x900 sliding doors

Features



10 year warranty

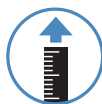

Height 1990mm



Easy maintenance

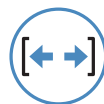

Left or right installation



Ease of installation



Shower included



Silicone free



Glass 5mm panels 5mm door









WALL
GLASS
PANELS

Cubicles

Kineprime Glass 1000x800 sliding doors
Thermostatic shower comes as standard with Kineprime Glass. Adjustable tray height for uneven floors

Product codes

Size						
700 x 700	CA720TTN	CA700TTN	CA740TTN	-	-	-
800 x 800	CA721TTN	CA701TTN	CA741TTN	CA781TTN	CA761TTN	CA9020TTN
900 x 900	CA722TTN	CA702TTN	CA742TTN	CA782TTN	CA762TTN	CA9030TTN
1000 x 800	CA713TTN	CA703TTN	CA743TTN	-	-	-



Kineprime Glass 900x900 recess pivot door



Rub-clean handset



Thermostatic shower

Dimensions

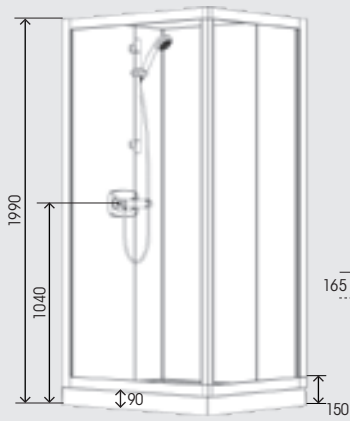

Overall shower and tray height is the same for all variants.

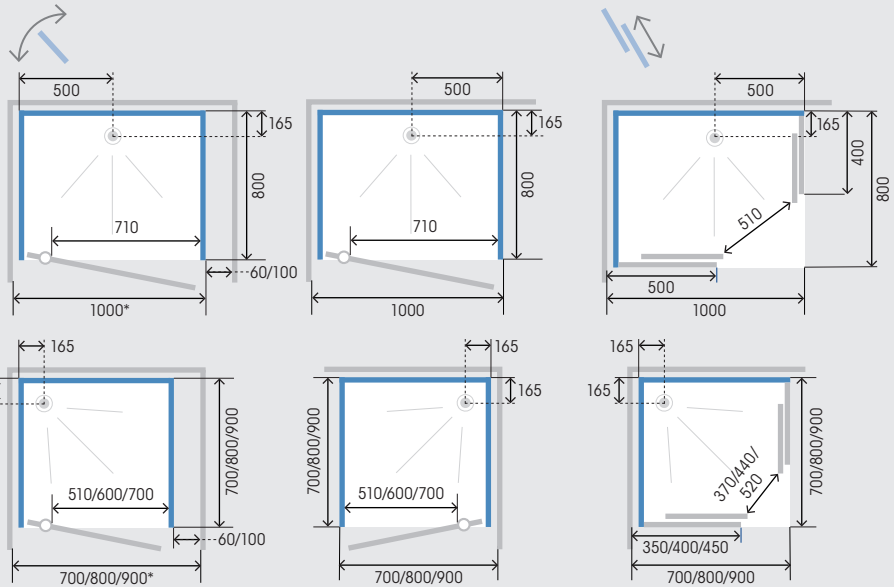

*for a recess unit please ensure there is a 60/100 mm gap at the side for installation

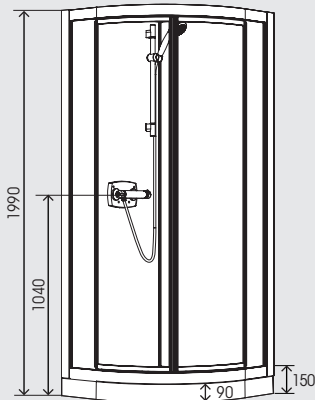

Overall shower and tray height is the same for all variants.

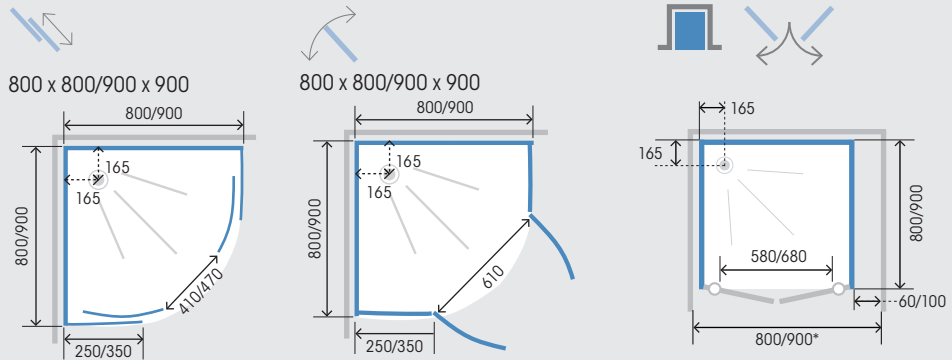

*for a recess unit please ensure there is a 60/100 mm gap at the side for installation

All measurements in mm

Kineprime Contract

The Kineprime Contract is an effective and neat solution when extra showering facilities are needed. This all-in-one shower cubicle is easy to clean and perfect for rental properties and student accommodation.

The attractive white framed cubicle combines stylish glass doors with practical plastic wall panels and is supplied with a thermostatic shower valve. This cubicle is easy and quick to install and doesn't even require any tools for the build. This self-contained cubicle comes in a variety of sizes and has either a sliding door or pivot, it also comes in a sliding door quadrant version. The plastic wall panel contains a convenient shelf for bottles.

- All-in-one shower cubicle
- White profile and plastic walls
- Sliding and pivot doors available
- Thermostatic shower included

Colours



White

Installation



Sliding door



Pivot door



Corner



Quadrant



Recess

Fit your space

	700	800	900	1000		800	900		900
700	✓	✗	✗	✗	✗	800	✓	✗	✗
800	✗	✓	✗	✗	✗	900	✓	✗	✗
900	✗	✗	✓	✗	✗	✗	✗	✓	✗

Sliding door Pivot door

All measurements in mm

If installing in a recess please check the sizing of the unit as a minimum of 60mm extra is needed for installation purposes. E.g. a 700 cubicle would need a minimum 760mm space.

Product codes

Size				
700 x 700	CA540TTN	CA510TTN	CA400TTN	CA5509TTN
800 x 800	CA560TTN	CA530TTN	CA600TTN	-
900 x 900	-	CA550TTN	-	-
1000 x 800	-	CA570TTN	-	-

* Quadrant is only available with sliding door.

Dimensions

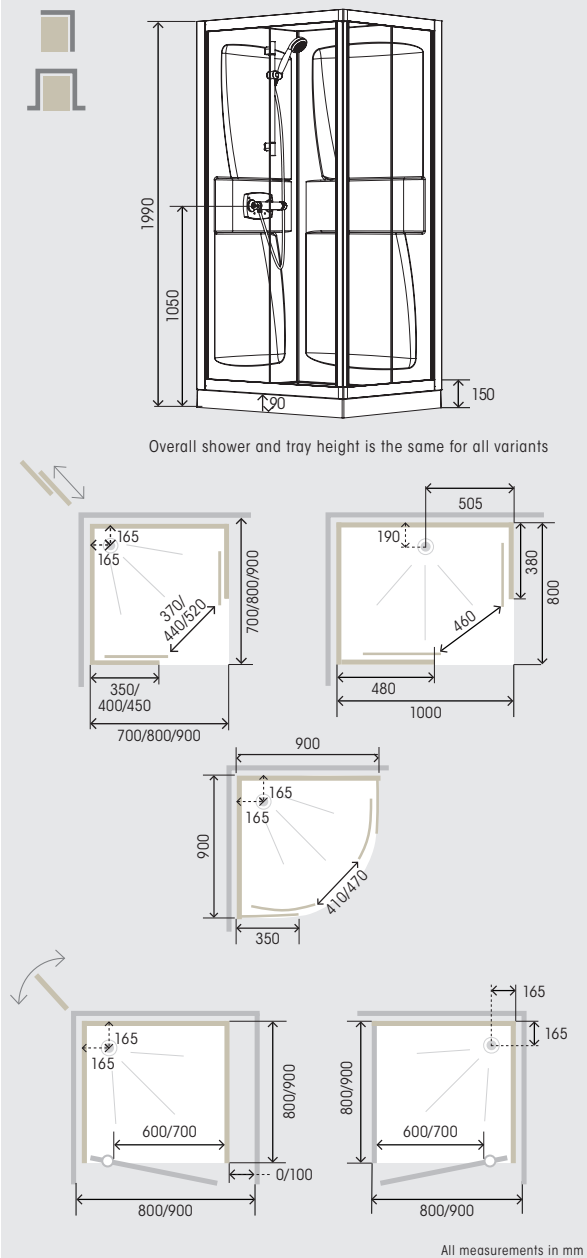

Features





Kineprime Contract 1000x800 sliding doors

Cubicles

Consort

Its simplicity of design, ease of installation and low maintenance, makes the Consort shower cubicle a winner for both domestic and commercial bathrooms.

Ideal for use in public buildings such as gyms, or for welfare units, the Consort can be fitted with your own choice of electric or mixer shower control and has inward opening saloon style styrene doors for maximum space efficiency in the bathroom. This cubicle is great for commercial applications where multi-installations are needed.

A new 900x900 consort has been added to the range. It comes with a manual shower valve already in place but this can be switched out if needed.

- All-in-one shower cubicle
- White profile and Styrene doors
- Saloon doors
- No shower included in 700 and 800
- Mechanical valve included in 900 version
- No silicone needed

Colours



White

Installation



Saloon door



Corner



Against a wall

Fit your space

	700	800	900
700	✓		
800		✓	
900			✓

✓ Saloon doors

All measurements in mm

Product codes

	Size	☑	☑
No shower	700 x 700	CA16GB	CA16GB
No shower	800 x 800	CA10GB	CA10GB
Shower valve (mechanical)	900 x 900	CA90GB	CA90GB



Consort 900x900 saloon doors – shower included

Dimensions

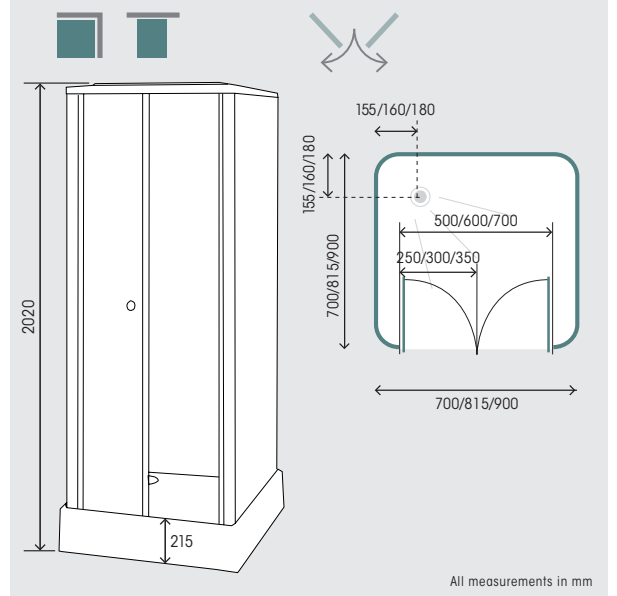

All measurements in mm

Features



10 year warranty



Height 2020mm



Easy maintenance

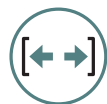

Left or right installation



Ease of installation



Silicone free



Cubicles

Consort 800x800 saloon doors

Brehat Fast

A simple and easy to install solution perfect for mobile homes. Create your own personalised design to suit your bespoke project by selecting from the vast range of different wall panels on offer. The Brehat Fast comes with a choice of either pivot or saloon doors.

- Available in 800 x 800 or 1000 x 800
- Comes with a choice of 1 pivot door 6mm glass or saloon doors
- 70mm tray height
- 90mm diameter waste with vertical outlet provided and polished stainless-steel waste cover
- White aluminium composite panels with the possibility to personalise them
- Aluminium profiles and integrated handles
- Interchangeable side panels to allow the shower mixer on the left or right and for the door to open on the left or right
- White profile and tray



Colours



White

Installation



Pivot door



Saloon door



Corner



Recess

Product codes and dimensions

Size		Product code
800 x 800	1 pivot door white	KINC065
1000 x 800	1 pivot door white	KINC067
800 x 800	2 saloon doors white	KINC069

For bespoke pattern panels please speak to your Kinexo representative. For Kinewall patterns please see page 136.

Dimensions

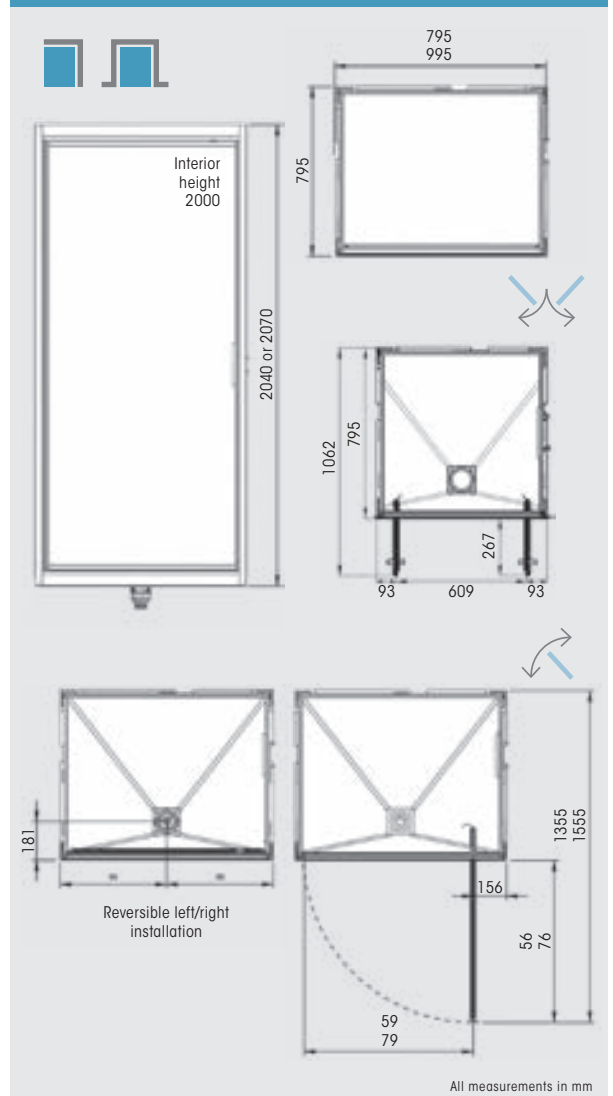

Features

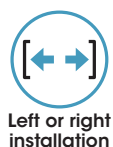



Brehat Fast 800x800 pivot door

Kinemagic Design

Sleek, opaque, white glass panels and a transparent glass front with anodised finish means the Kinemagic Design is in a class of its own.

With a low height tray, thermostatic valve and range of sizes the Kinemagic Design can fit in most bathrooms. The clever construction of all the Kinemagic range enables it to be fitted in just one day with no mess or fuss and no re-tiling. Making our Kinemagic range one of most stylish, practical, versatile and most popular range of showers.

- 38mm shower tray threshold for easy entry
- Stylish thermostatic valve with integrated glass shelf
- Drenching overhead rain shower
- Unique, adjustable feet for unbreachable and uneven floors
- White opaque glass panels with transparent glass door and side panel (if corner) complete the stylish look of this shower cubicle

Colours



Anodised silver finish

Installation



Sliding door



Saloon door



Corner



Recess

Fit your space

	1000	1200	1400	1600	1700		1000	1200	1400	1600	1700
700	✓	✓	✓	✓	✓	Sliding door	✓	✓	✓	✓	✓
800	✓	✓	✓	✓	✓	Saloon doors	✓	✓	✓	✓	✓
900	✓	✓	✓	✓	✓	Saloon doors	✓	✓	✓	✓	✓

✓ Sliding door ✓ Saloon doors

All measurements in mm



Kinemagic Design 1000x800 saloon doors



Kinemagic Design 1600x900 recess sliding door

Features



10 year warranty



Height 2310mm



Easy maintenance

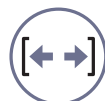

Left or right installation



Ease of installation



Anti-limescale



Shower included



Silicone free







Glass 6mm panels 8mm door



Cubicles

Kinemagic Design 1600x800 sliding door

Product codes

Size				
1000 x 700	-	-	DEST C1070S	DEST R1070S
1000 x 800	-	-	DEST C1080S	DEST R1080S
1000 x 900	-	-	DEST C1090S	DEST R1090S
1200 x 700	DEST C1270	DEST R1270	DEST C1270S	DEST R1270S
1200 x 800	DEST C1280	DEST R1280	DEST C1280S	DEST R1280S
1200 x 900	DEST C1290	DEST R1290	DEST C1290S	DEST R1290S
1400 x 700	DEST C1470	DEST R1470	-	-
1400 x 800	DEST C1480	DEST R1480	-	-
1400 x 900	DEST C1490	DEST R1490	-	-
1600 x 700	DEST C1670	DEST R1670	-	-
1600 x 800	DEST C1680	DEST R1680	-	-
1600 x 900	DEST C1690	DEST R1690	-	-
1700 x 700	DEST C1770	DEST R1770	-	-
1700 x 800	DEST C1780	DEST R1780	-	-
1700 x 900	DEST C1790	DEST R1790	-	-



Kinemagic Design 1000x800 saloon doors



Overhead rain shower

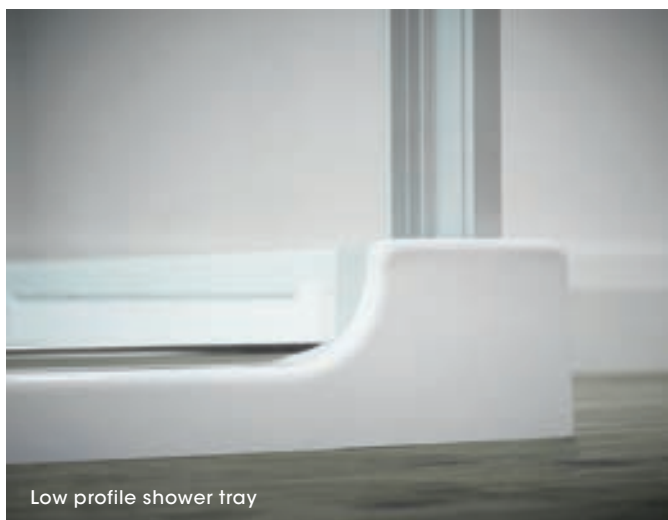

Low profile shower tray



Stylish shower valve and shelf

Dimensions

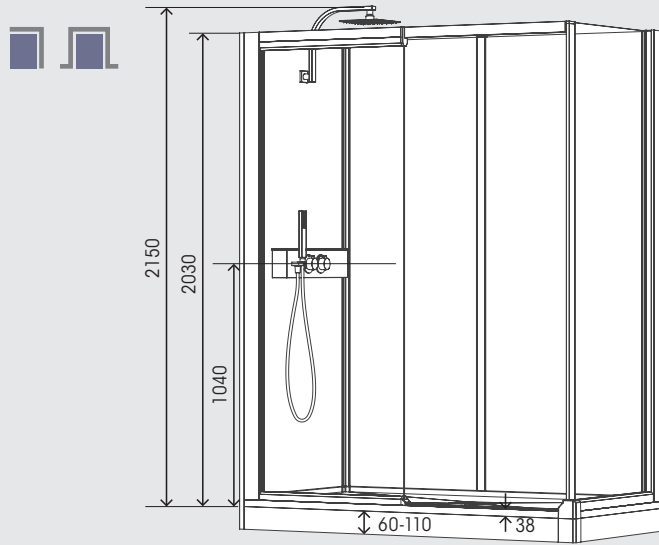

Reversible right / left installation

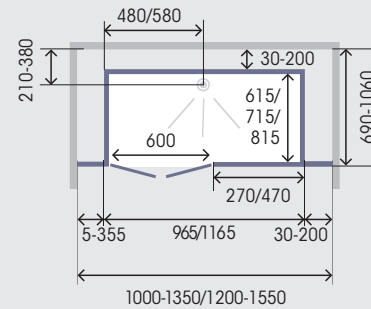
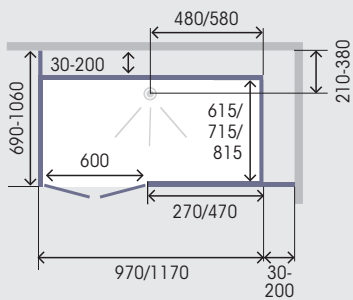
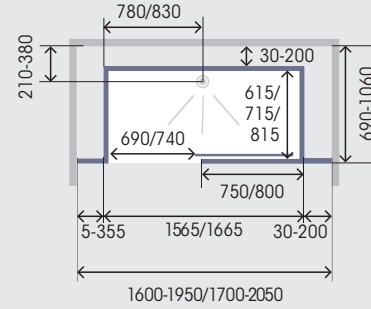
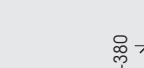
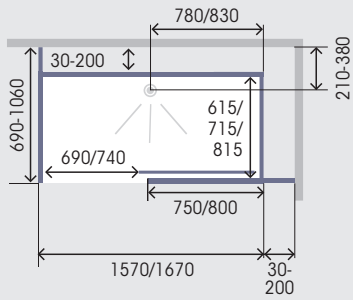
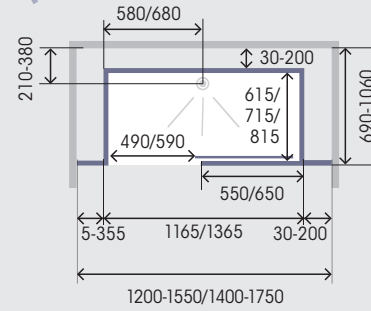
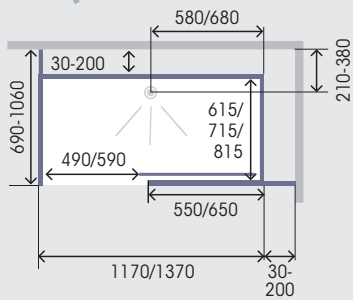

All measurements in mm

Kinemagic Serenity

The Kinemagic Serenity has been cleverly designed with all of the family in mind, it also gives peace of mind for those who seek that extra bit of safety in the shower.

This high quality, all-in-one shower cubicle has been designed to fit in exactly the same space as your old bath and with integrated thermostatic shower control, a comfortable fold-down seat that takes up to 150kg, anti-slip flooring and secure grab bars, it gives a luxury feel whilst providing reassurance and comfort.

- 38mm shower tray threshold for easy entry
- Thermostatic shower with ergonomic controls
- Two grab bars included
- Anti-slip shower tray
- Fold down seat
- Unique, adjustable feet for unbreachable and uneven floors
- Serenity + version is available with additional grab bar, please speak to a Kinedo sales representative for further information



Kinemagic Serenity 1700x900 recess sliding door

Colours



Chrome

Installation



Sliding door



Corner



Recess

Fit your space

	1200	1400	1600	1700		1200	1400	1600	1700
700	☑	☑	☑	☑	700	☑	☑	☑	☑
800	☑	☑	☑	☑	800	☑	☑	☑	☑
900	☑	☑	☑	☑	900	☑	☑	☑	☑

☑ Sliding door

All measurements in mm

Features



10 year warranty



Height 2090mm



Easy maintenance

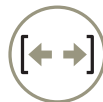

Left or right installation



Ease of installation



Anti-limescale



Shower included



Silicone free



Antislip and PN24



Glass 6mm panels 8mm door



WALL
GLASS
PANELS

Cubicles

Kinemagic Serenity 1600x800 sliding door

Product codes

Size		
1200 x 700	SERENT C1270	SERENT R1270
1200 x 800	SERENT C1280	SERENT R1280
1200 x 900	SERENT C1290	SERENT R1290
1400 x 700	SERENT C1470	SERENT R1470
1400 x 800	SERENT C1480	SERENT R1480
1400 x 900	SERENT C1490	SERENT R1490
1600 x 700	SERENT C1670	SERENT R1670
1600 x 800	SERENT C1680	SERENT R1680
1600 x 900	SERENT C1690	SERENT R1690
1700 x 700	SERENT C1770	SERENT R1770
1700 x 800	SERENT C1780	SERENT R1780
1700 x 900	SERENT C1790	SERENT R1790



Dimensions

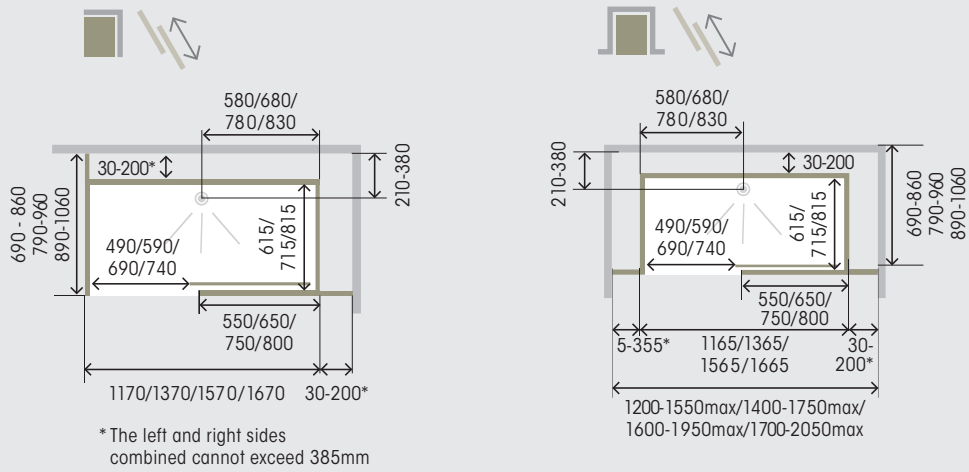
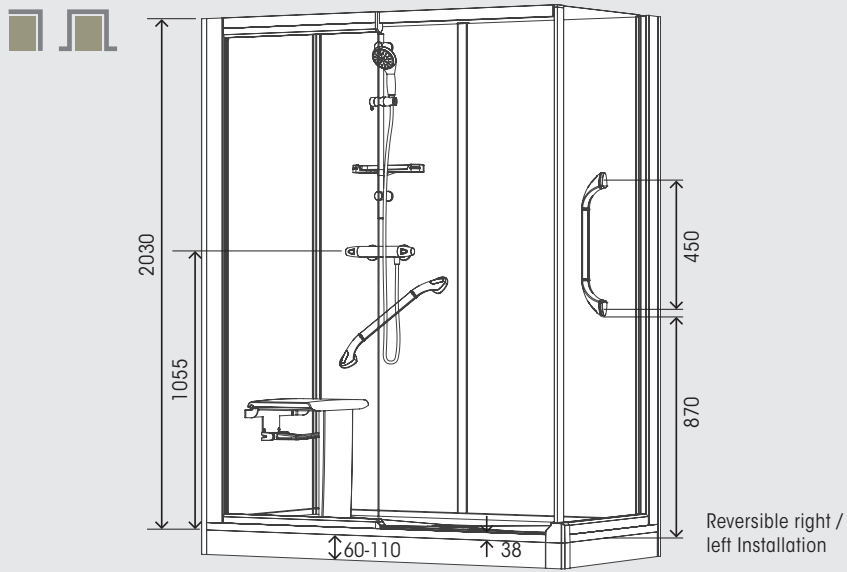

All measurements in mm



En-suite

CONTENTS

MODULO 122 - 125

MODULO XL 126 - 129



10 year
warranty



Easy
maintenance



Ease of
installation



Anti-limescale



No need for
major preliminary
works



Completed
in 2-3 days



Shower
included

Modulo

The complete bathroom solution. Modulo allows you to install a bathroom easily without major work and considerably reducing installation time and costs.

The modulo is an all in one bathroom that can be added into a room as long as there is small bore pipework and electricity you can add an en-suite in a couple of days!

With different profile and glass options you can tailor the Modulo for your needs. Its black or white design create a modern space that fits in with any decor.

With a shower and basin you can create a new bathroom in a space 170cm x 102cm or with a WC included in a space 200cm by 102cm. Modulo can add an en-suite transforming a room and adding value to your property.

Shower + handbasin

- Self-supporting platform in Biocryl on height-adjustable feet, with finishing plinths
- Opaque white glass back panels
- White honeycomb polypropylene ceiling with 2 integrated LED spotlights
- Fully equipped with mirror, glass shelves, towel hook, ventilation grill, 220 V socket, floor mat

3 finishes available

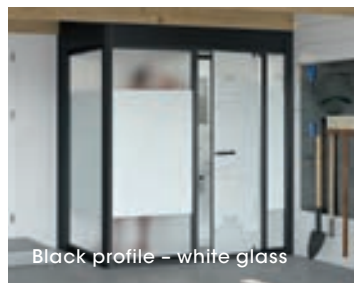
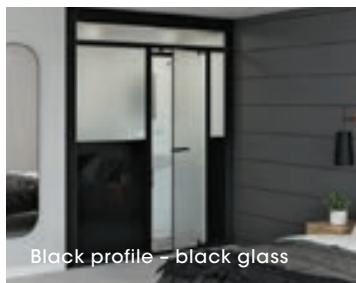

Luxe

- Shower with sliding door
- Mechanical shower valve and hand shower
- Wall hung wash basin vanity unit
- Towel rail



Standard

- Shower area with curtain shower rail
- Mechanical shower valve and hand shower
- Washbasin with mixer tap



Colours



White



Black

Installation



Pivot door



Corner



Recess

Features



10 year warranty



Easy maintenance



Ease of installation



Anti-limescale



No need for major preliminary works



Completed in 2-3 days



Shower included



6mm glass



Modulo standard white profile - white glass

Product codes

Modulo	Without grey water pump			
	Recess		Corner	
	Shower on the left	Shower on the right	Shower on the left	Shower on the right
Low version				
White profile – White glass	MOB17NGBBDT	MOB17NDBBDT	MOB17AGBBDT	MOB17ADBBDT
Black profile – White glass	MOB17NGNBDT	MOB17NDNBDT	MOB17AGNBDT	MOB17ADNBDT
Black profile – Black glass	MOB17NGNNDT	MOB17NDNNDT	MOB17AGNNDT	MOB17ADNNDT
High version				
White profile – White glass	MO17NGBBDT	MO17NDBBDT	MO17AGBBDT	MO17ADBBDT
Black profile – White glass	MO17NGNBDT	MO17NDNBDT	MO17AGNBDT	MO17ADNBDT
Black profile – Black glass	MO17NGNNDT	MO17NDNNDT	MO17AGNNDT	MO17ADNNDT

Modulo	With grey water pump			
	Recess		Corner	
	Shower on the left	Shower on the right	Shower on the left	Shower on the right
Low version				
White profile – White glass	MOB17PNGBBDT	MOB17PNDBBDT	MOB17PAGBBDT	MOB17PADBBDT
Black profile – White glass	MOB17PNGNBDT	MOB17PNDNBDT	MOB17PAGNBDT	MOB17PADNBDT
Black profile – Black glass	MOB17PNGNNDT	MOB17PNDNNDT	MOB17PAGNNDT	MOB17PADNNDT
High version				
White profile – White glass	MO17PNGBBDT	MO17PNDBBDT	MO17PAGBBDT	MO17PADBBDT
Black profile – White glass	MO17PNGNBDT	MO17PNDNBDT	MO17PAGNBDT	MO17PADNBDT
Black profile – Black glass	MO17PNGNNDT	MO17PNDNNDT	MO17PAGNNDT	MO17PADNNDT

Modulo Luxe	Without grey water pump			
	Recess		Corner	
	Shower on the left	Shower on the right	Shower on the left	Shower on the right
Low version				
White profile – White glass	MOLB17NGBBDT	MOLB17NDBBDT	MOLB17AGBBDT	MOLB17ADBBDT
Black profile – White glass	MOLB17NGNBDT	MOLB17NDNBDT	MOLB17AGNBDT	MOLB17ADNBDT
Black profile – Black glass	MOLB17NGNNDT	MOLB17NDNNDT	MOLB17AGNNDT	MOLB17ADNNDT
High version				
White profile – White glass	MOL17NGBBDT	MOL17NDBBDT	MOL17AGBBDT	MOL17ADBBDT
Black profile – White glass	MOL17NGNBDT	MOL17NDNBDT	MOL17AGNBDT	MOL17ADNBDT
Black profile – Black glass	MOL17NGNNDT	MOL17NDNNDT	MOL17AGNNDT	MOL17ADNNDT

Modulo Luxe	With grey water pump			
	Recess		Corner	
	Shower on the left	Shower on the right	Shower on the left	Shower on the right
Low version				
White profile – White glass	MOLB17PNGBBDT	MOLB17PNDBBDT	MOLB17PAGBBDT	MOLB17PADBBDT
Black profile – White glass	MOLB17PNGNBDT	MOLB17PNDNBDT	MOLB17PAGNBDT	MOLB17PADNBDT
Black profile – Black glass	MOLB17PNGNNDT	MOLB17PNDNNDT	MOLB17PAGNNDT	MOLB17PADNNDT
High version				
White profile – White glass	MOL17PNGBBDT	MOL17PNDBBDT	MOL17PAGBBDT	MOL17PADBBDT
Black profile – White glass	MOL17PNGNBDT	MOL17PNDNBDT	MOL17PAGNBDT	MOL17PADNBDT
Black profile – Black glass	MOL17PNGNNDT	MOL17PNDNNDT	MOL17PAGNNDT	MOL17PADNNDT

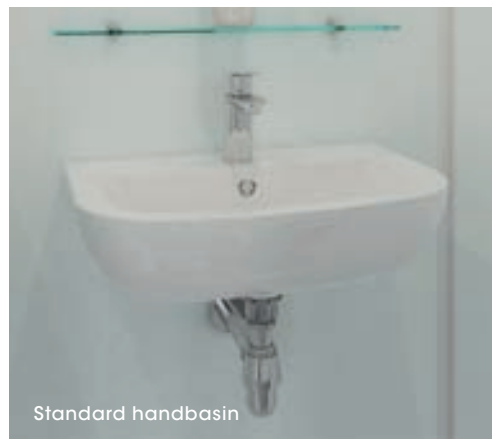

Standard handbasin



Washbasin vanity unit



Modulo Standard

Dimensions

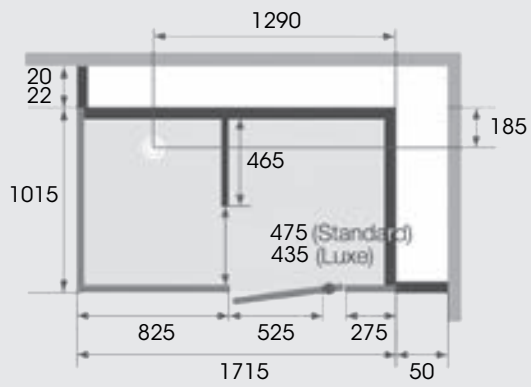
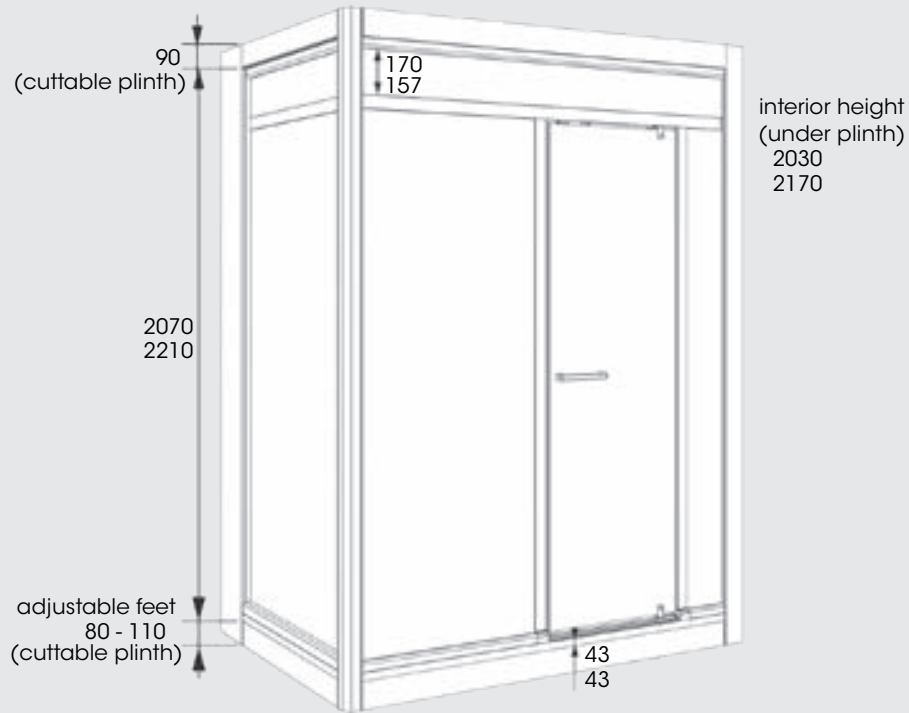

Shower on the right

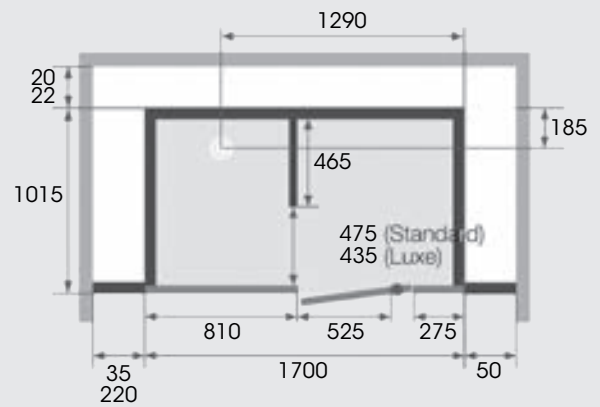

Shower on the right



All measurements in mm

Modulo XL

Shower + handbasin + WC

- Self-supporting platform in Biocryl on height-adjustable feet, with finishing plinths
- Opaque white glass back panels
- White honeycomb polypropylene ceiling with 2 integrated LED spotlights. Fully equipped with mirror, glass shelves, towel hook, toilet roll holder, ventilation grill, 220 V socket, floor mat
- Door latch included

3 finishes available

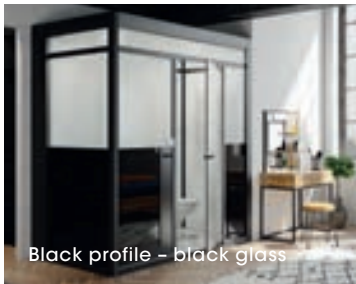

Luxe

- Shower with sliding door
- Mechanical shower valve and hand shower
- Wall hung vanity wash basin
- Wall hung toilet
- Towel rail



Standard

- Shower area with curtain shower rail
- Mechanical shower valve and hand shower
- Washbasin with mixer tap
- Wall hung toilet

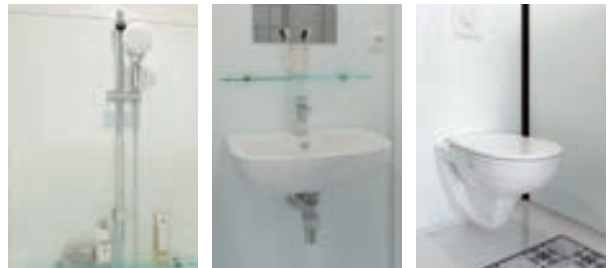

Colours



White



Black

Installation



Pivot door



Corner



Recess

Features



10 year warranty



Easy maintenance



Ease of installation



Anti-limescale



No need for major preliminary works



Completed in 2-3 days



Shower included



6mm glass



Modulo XL - black profile - black glass

En-suite

Product codes

Modulo XL

Without macerator pump

Low version	Recess		Corner	
	Shower on the left	Shower on the right	Shower on the left	Shower on the right
White profile – White glass	MOB20WNGBBDT	MOB20WNBBDT	MOB20WAGBBDT	MOB20WADBBDT
Black profile – White glass	MOB20WNGNBDT	MOB20WNDNBDT	MOB20WAGNBDT	MOB20WADNBDT
Black profile – Black glass	MOB20WNGNNDT	MOB20WNDNNDT	MOB20WAGNNDT	MOB20WADNNDT

Modulo XL

With macerator pump

Low version	Recess		Corner	
	Shower on the left	Shower on the right	Shower on the left	Shower on the right
White profile – White glass	MOB20WBNGBBDT	MOB20WBNDBBDT	MOB20WBAGBBDT	MOB20WBADBBDT
Black profile – White glass	MOB20WBNGNBDT	MOB20WBNDNBDT	MOB20WBAGNBDT	MOB20WBADNBDT
Black profile – Black glass	MOB20WBNGNNDT	MOB20WBNDNNDT	MOB20WBAGNNDT	MOB20WBADNNDT

Modulo XL Luxe

Without macerator pump

Low version	Recess		Corner	
	Shower on the left	Shower on the right	Shower on the left	Shower on the right
White profile – White glass	MOLB20WNGBBDT	MOLB20WNBBDT	MOLB20WAGBBDT	MOLB20WADBBDT
Black profile – White glass	MOLB20WNGNBDT	MOLB20WNDNBDT	MOLB20WAGNBDT	MOLB20WADNBDT
Black profile – Black glass	MOLB20WNGNNDT	MOLB20WNDNNDT	MOLB20WAGNNDT	MOLB20WADNNDT

Modulo XL Luxe

With macerator pump

Low version	Recess		Corner	
	Shower on the left	Shower on the right	Shower on the left	Shower on the right
White profile – White glass	MOLB20WBNGBBDT	MOLB20WBNDBBDT	MOLB20WBAGBBDT	MOLB20WBADBBDT
Black profile – White glass	MOLB20WBNGNBDT	MOLB20WBNDNBDT	MOLB20WBAGNBDT	MOLB20WBADNBDT
Black profile – Black glass	MOLB20WBNGNNDT	MOLB20WBNDNNDT	MOLB20WBAGNNDT	MOLB20WBADNNDT



Wall hung toilet



Washbasin vanity unit



Modulo Standard

Dimensions

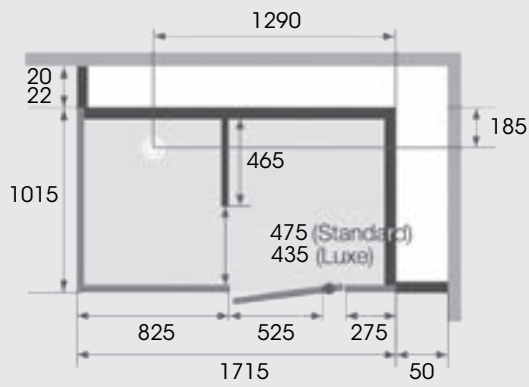
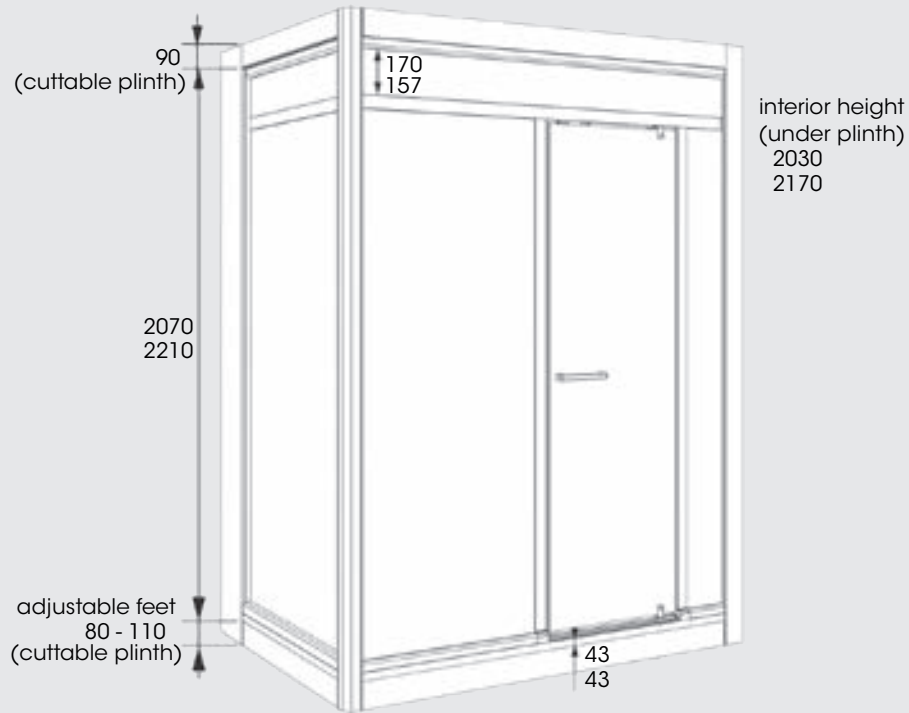

Shower on the right

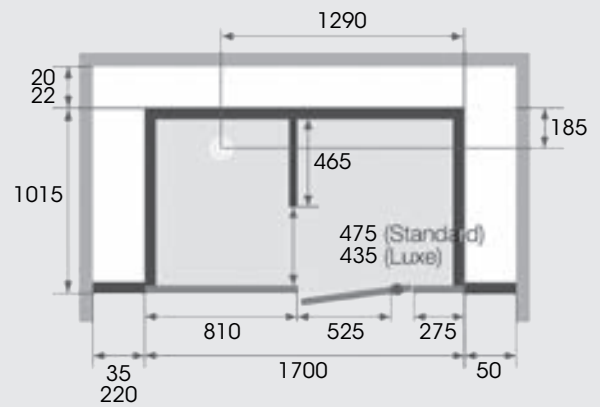

Shower on the right



All measurements in mm



Shower/bath

CONTENTS

KINEDUO

132 - 135



10 year
warranty



Easy
maintenance



Left or right
installation



Ease of
installation



Anti-limescale

Kineduo

The Kineduo offers you the best of both worlds, packed full of practical features designed to make bathing and showering a pleasure.

With its simple step-in access using a hinged, toughened safety glass door, the Kineduo is equally appealing to able-bodied and less able users as it makes taking a bath or shower easy and trouble-free.

The Kineduo can replace any existing bath regardless of positioning within the bathroom. With optional extras such as the end glass shower panel you can position the shower where you want it, so you can still have a shower bath even if your bathroom has a window or is in the eaves.

With white glass bath panels, the Kineduo can fit into any colour scheme and really creates a premium feel whilst still being designed to be inclusive for all the family. With a grab bar for the screen and a seat, the Kineduo can be tailored to your individual needs, without losing its style.

As standard the Kineduo is supplied with a toughened safety glass door, a cushioned headrest and pop up plug. Then just add the optional extras you want to make this unique to your home. You can now achieve luxury and convenience at an affordable price with Kineduo.

- Combined shower bath with glass door for easy access
- Different combinations possible to configure the bath to exactly what you need
- Head rest included as standard
- Different shower and tap combinations available

Colours



Chrome



White

Installation



Corner



Recess



Head rest

Features



10 year warranty



Easy maintenance



Left or right installation



Ease of installation



Anti-limescale

Fit your space

	1600	1700	1800
750			
800			

Bath with left or right headrest

All measurements in mm



Kineduo with glass screen with hinged section - with T grab bar and magnetic handshower

Product codes

Size	
1600 x 750 (right)	KD316R
1600 x 750 (left)	KD316L
1700 x 750 (right)	KD317R
1700 x 750 (left)	KD317L
1800 x 800 (right)	KD318R
1800 x 800 (left)	KD318L



Shower/bath

Kineduo with glass screen with hinged section and glass end screen - with T grab bar and magnetic handshower



Simple door latch



Magnetic shower head and T bar



Swan neck overhead shower

Dimensions



1600 x 750mm

1700 x 750mm

1800 x 800mm

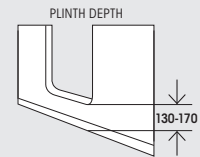
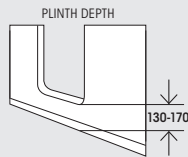
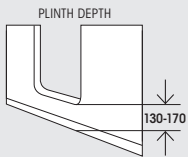
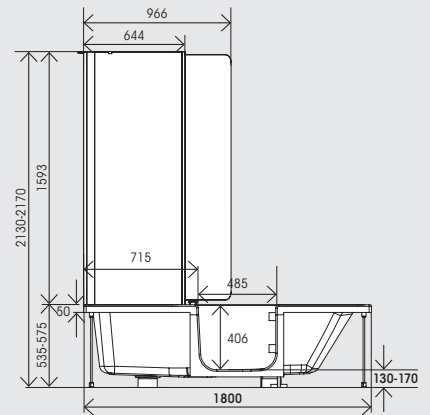
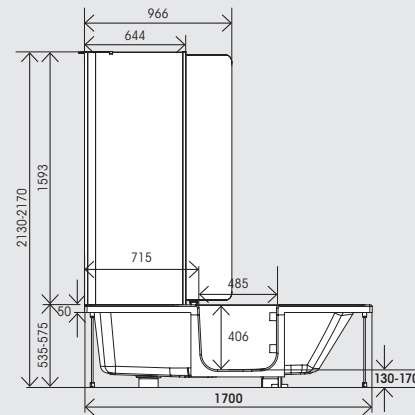
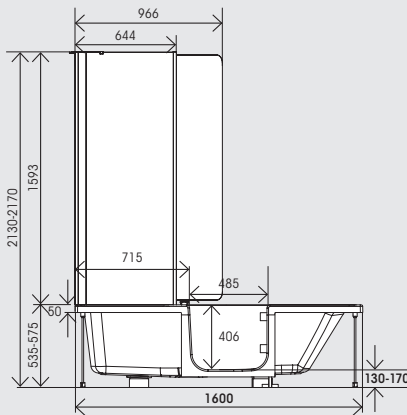

Upstands shown around top of bath are available separately – please ask for details.

All measurements in mm

Design your own Kineduo

Use our Kineduo configurator configurator.kinedo.co.uk

This will show you not only how your finished shower bath could look but also list the parts with codes and costs.

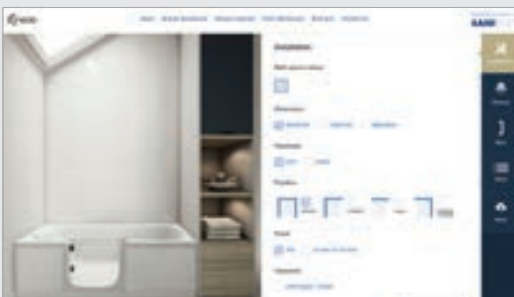

Optional extras

Make the Kineduo uniquely yours with our optional extras.



Taps & showers

Thermostatic tap and waterfall filler – Chrome	OPK-RTHD4/20
Classic shower set – Chrome (order taps and filler separately)	OPT-BDSD4/00-OF
T grab bar, rail and magnetic handshower – White (order taps and filler separately)	OPT-BDTIN/00-OF
Thermostatic overhead shower with swan neck rail – Chrome (supplied with taps and waterfall filler)	OPK-CTHD4/20
Overflow filler – Chrome	VID-ALDUO/20-OF



Screens

Glass screen with hinged section incl. wall brace	OPT-PRD4S/XX-OF
---	-----------------



Grab bars

Screen grab bar Chrome	OPT-PGENT/20-OF
------------------------	-----------------

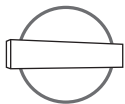

Upstands

Upstands – recess (three part)	PCK-CRED-NICHE-OF
Upstands – corner (two part)	PCK-CRED-CORNER-OF



Bath seat

Fold down seat – soft close	OPKSGKD400
-----------------------------	------------



Easy-click front glass panels

Front panel only (for recess) – white	1600 x 750	TAB-D467FVN/00
	1700 x 750	TAB-D477FVN/00
	1800 x 800	TAB-D418FVN/00
Front and end panel (for corner) – white	1600 x 750	TAB-D467FVA/00
	1700 x 750	TAB-D477FVA/00
	1800 x 800	TAB-D418FVA/00
Front and 2 end panels (for against a wall) – white	1600 x 750	TAB-D467FVS/00
	1700 x 750	TAB-D477FVS/00
	1800 x 800	TAB-D418FVS/00



Glass bath end screen

Glass bath end screen	750 for 1600 and 1700 bath	OPT-RD475/XX-OF
	800 for 1800 bath	OPT-RD480/XX-OF

For extra comfort and safety we recommend fitting a separate TMV valve with the Kineduo taps and shower.



Non-slip surface

Non-slip surface finish for Duo	OPT-GPKD3/XX-OF
---------------------------------	-----------------

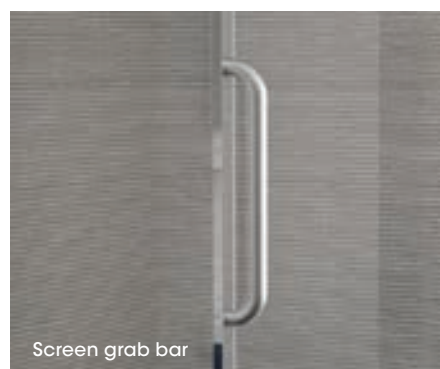
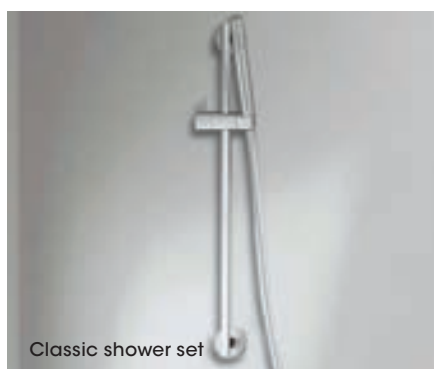

Kinewall

CONTENTS

MIXED DESIGNS	142 - 145
MINERALS & METALS	146 - 149
NATURE	150 - 153
PATTERNS & GEOMETRIC	154 - 157
WOOD	158 - 161
KINEWALL ACCESSORIES	163
INSTALLATION	164 - 165



More than
70 designs



10 year
warranty



Ease of
installation

Why just install a shower when you can transform your shower space or your whole bathroom with Kinewall

Kinewall bathroom wall panels from Kinedo offer you a fantastic alternative to tiles.

Whether you are adding a shower or renovating your whole bathroom Kinewall is easy to install, and with over 70 designs to choose from you can create the perfect bathroom whatever your style.

polyethylene core

2 aluminium layers

design printed and varnished in our factory in France

3mm

An innovative solution



More than 70 designs



10 year Warranty



Ease of installation



Minimal preparation needed



Easy maintenance



100% waterproof



Lightweight & durable



Easy to cut

Available in 6 sizes

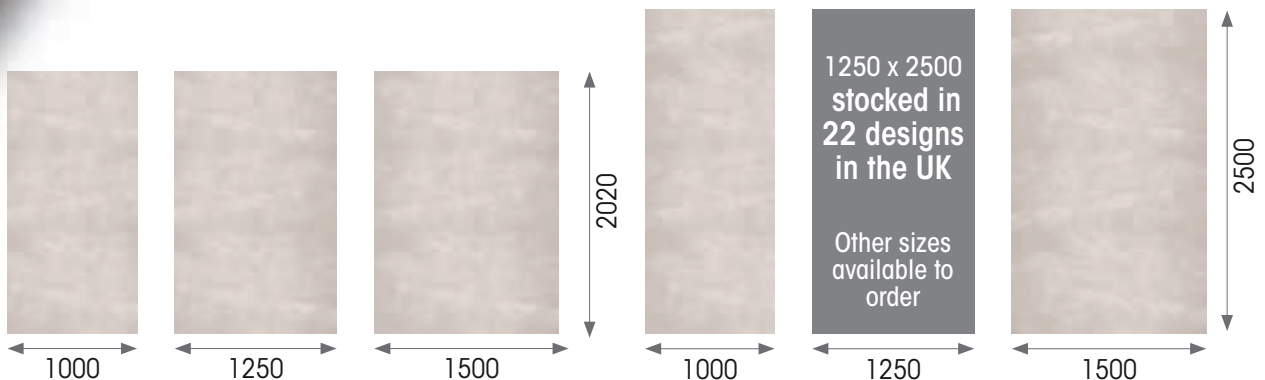

1250 x 2500 stocked in 22 designs in the UK

Other sizes available to order

All measurements in mm

22
DESIGNS
STOCKED IN
THE UK

Stocked in the UK



Blue Grey Marble
1000mm x 2500mm: PM602
1250mm x 2500mm: PM802
1500mm x 2500mm: PM1002

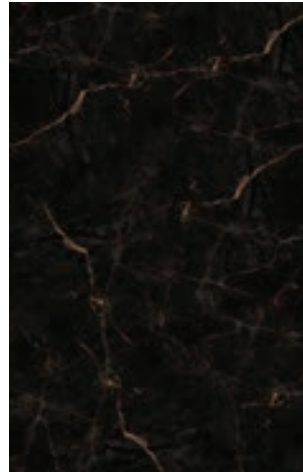

Black & Copper Marble
1000mm x 2500mm: PM604
1250mm x 2500mm: PM804
1500mm x 2500mm: PM1004



Cement Grey Tiles
1000mm x 2500mm: PM610
1250mm x 2500mm: PM810
1500mm x 2500mm: PM1010



Grey Geometric Wave
1000mm x 2500mm: PM611
1250mm x 2500mm: PM811
1500mm x 2500mm: PM1011



Banana Trees
1000mm x 2500mm: PM619
1250mm x 2500mm: PM819
1500mm x 2500mm: PM1019



Banana Trees Black & White
1000mm x 2500mm: PM620
1250mm x 2500mm: PM820
1500mm x 2500mm: PM1020



Jungle
1000mm x 2500mm: PM616
1250mm x 2500mm: PM816
1500mm x 2500mm: PM1016



Blue Monochrome Hexagon
1000mm x 2500mm: PM450
1250mm x 2500mm: PM340
1500mm x 2500mm: PM360



Grey Monochrome Hexagon
1000mm x 2500mm: PM451
1250mm x 2500mm: PM341
1500mm x 2500mm: PM361



Hexagon Trilogy
1000mm x 2500mm: PM638
1250mm x 2500mm: PM838
1500mm x 2500mm: PM1038



White Waves
1000mm x 2500mm: PM640
1250mm x 2500mm: PM840
1500mm x 2500mm: PM1040

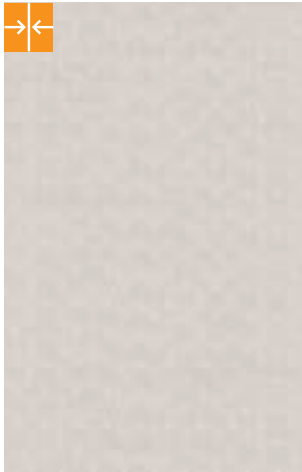

Beige Scalloped Edge

1000mm x 2500mm: PM630
1250mm x 2500mm: PM830
1500mm x 2500mm: PM1030

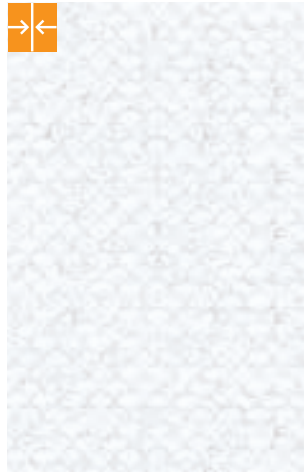

Marble Scalloped Edge

1000mm x 2500mm: PM634
1250mm x 2500mm: PM834
1500mm x 2500mm: PM1034

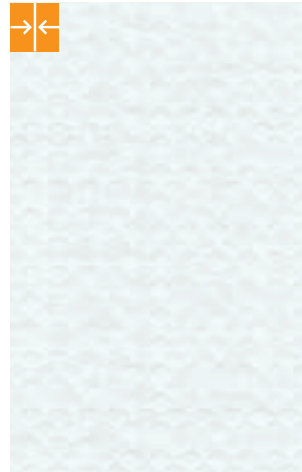

White Scalloped Edge

1000mm x 2500mm: PM631
1250mm x 2500mm: PM831
1500mm x 2500mm: PM1031

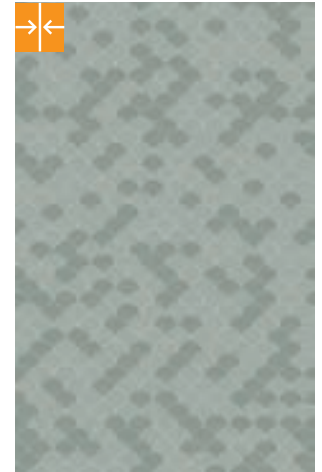

Sage Scalloped Edge

1000mm x 2500mm: PM632
1250mm x 2500mm: PM832
1500mm x 2500mm: PM1032



Terracotta Scalloped Edge

1000mm x 2500mm: PM633
1250mm x 2500mm: PM833
1500mm x 2500mm: PM1033

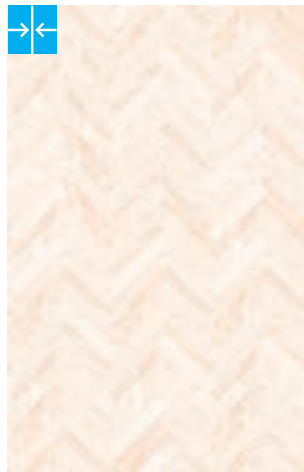

Herringbone

1000mm x 2500mm: PM461
1250mm x 2500mm: PM351
1500mm x 2500mm: PM371

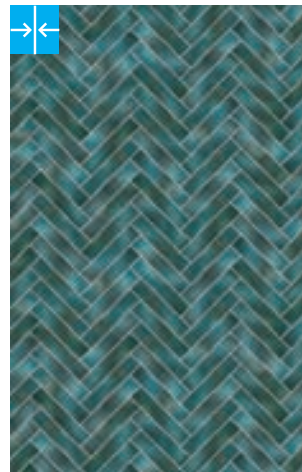

Green Blue Herringbone

1000mm x 2500mm: PM641
1250mm x 2500mm: PM841
1500mm x 2500mm: PM1041



Walnut Pencils

1000mm x 2500mm: PM636
1250mm x 2500mm: PM836
1500mm x 2500mm: PM1036



Graphic Wood Design

1000mm x 2500mm: PM643
1250mm x 2500mm: PM843
1500mm x 2500mm: PM1043



Vertical Wood Design

1000mm x 2500mm: PM644
1250mm x 2500mm: PM844
1500mm x 2500mm: PM1044

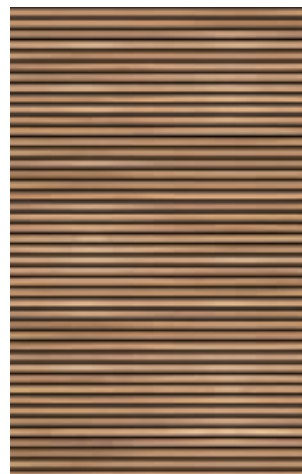

Horizontal Wood Design

1000mm x 2500mm: PM455
1250mm x 2500mm: PM345
1500mm x 2500mm: PM365



Consecutive pattern match across all widths



Consecutive pattern match in 1500mm width only

For full details and additional designs please see www.kinedo.co.uk/kinewall

More than 70 designs

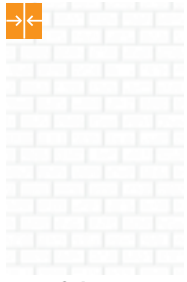

Subway



Blue Cladding + Blue Terrazzo

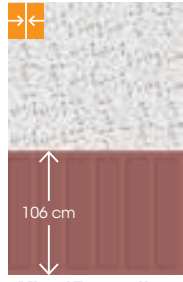

Mixed Terracotta + Terracotta Terrazzo

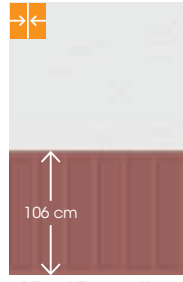

Mixed Terracotta + White Scalloped Edge

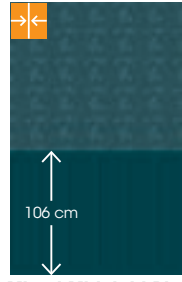

Mixed Midnight Blue + Exotica Blue

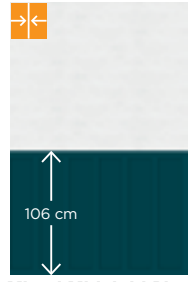

Mixed Midnight Blue + White Coating



Mixed Midnight Blue + Grey Terrazzo



Mixed Green + Grey Terrazzo

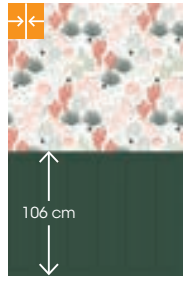

Mixed Green + Cactus



Alabaster

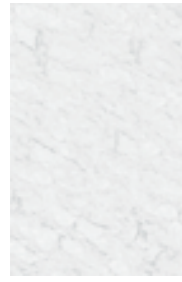

White Marble



Pink Marble



Blue Grey Marble

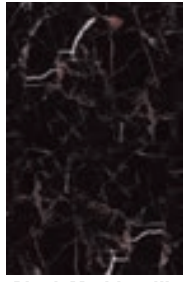

Black Marble with White & Copper

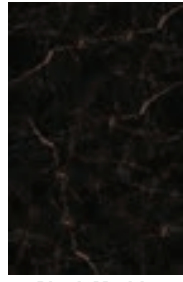

Black Marble with Copper

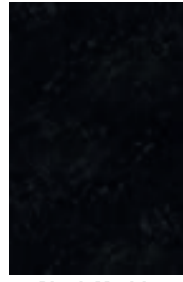

Black Marble

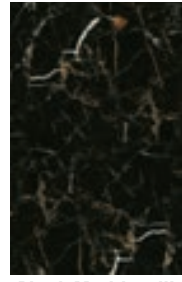

Black Marble with White & Gold

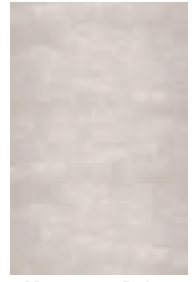

Moroccan Beige



Cement Strips



Cement Circles

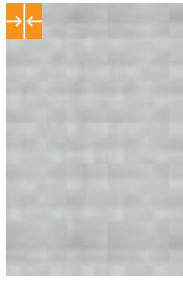

Cement Grey Tile



Grey Geometric Wave

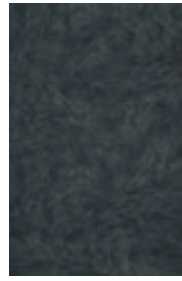

Dark Concrete

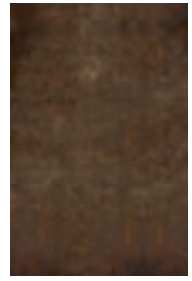

Corten Steel



White Brushed Stainless Steel Grey Brushed Stainless Steel



White Trowel



Cactus



Desert Cactus



Palm Trees

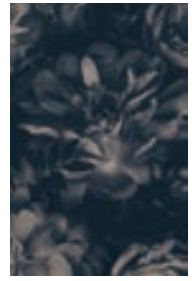

Floral



Banana Trees



Banana Trees Black & White



Jungle



Exotica Blue



Exotica Green

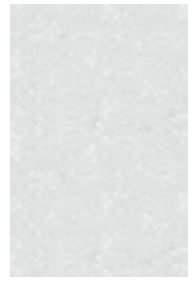

Grey Terrazzo



Consecutive pattern match across all widths



Consecutive pattern match in 1500mm width only



Blue Terrazzo



Terracotta Terrazzo



Pink Marble Pencils

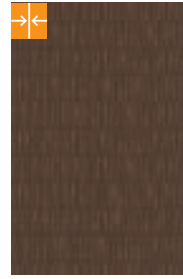

Walnut Pencils



Blue Monochrome Hexagon



Grey Monochrome Hexagon



Hexagon Trilogy

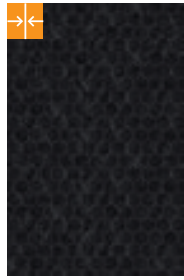

Black Marble Tile

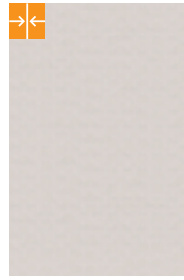

Beige Scalloped Edge

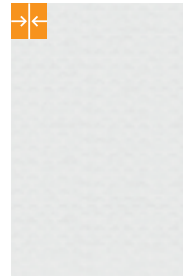

White Scalloped Edge

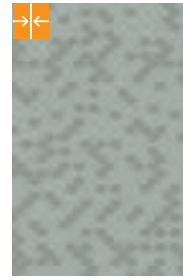

Sage Scalloped Edge



Terracotta Scalloped Edge



Marble Scalloped Edge

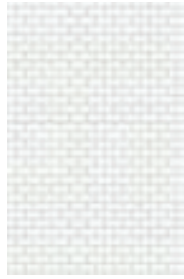

Metro

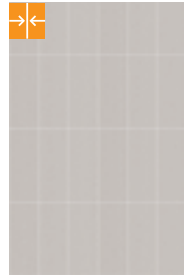

Earthenware Fabric



Herringbone

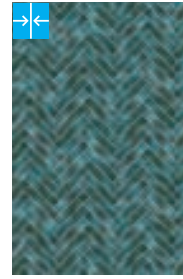

Green Blue Herringbone

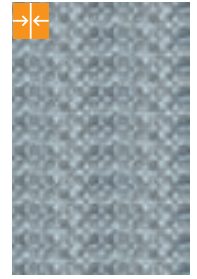

Vintage Blue Grey

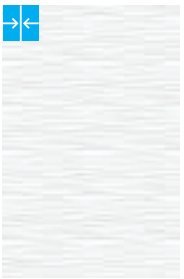

White Waves



Natural Oak



Graphic Wood Design



Vertical Wood Design Horizontal Design Wood Design

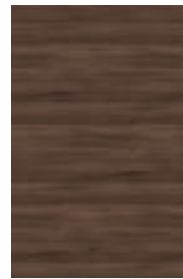

Walnut



White Cladding



Midnight Blue Vertical Panelling



Celadon Green Vertical Panelling

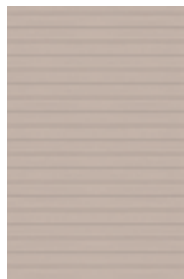

Beige Horizontal Panelling

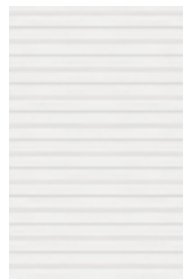

White Horizontal Panelling



Midnight Blue Horizontal Panelling



Terracotta Horizontal Panelling



Beige Coating



White Coating

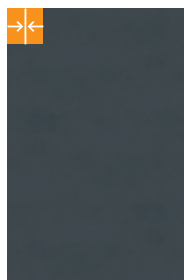

Anthracite Grey Coating

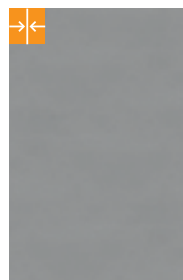

Stone Grey Coating

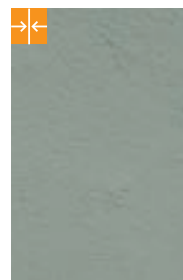

Sage Coating



Terracotta Coating

Mixed designs

With such a range of styles, colours and patterns to choose from you can have one design for your whole bathroom or choose a design for just your shower area or around a bath or basin. Why not mix and match patterns to create that perfect designer look. Our mixed panelling range of Kinewall designs are perfect to create this look.

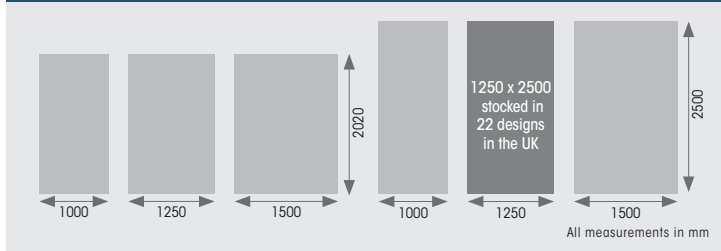

- Polyethylene core
- 2 aluminium layers
- Design printed and varnished in our factory in France
- 22 designs stocked in the UK size 1250x2500mm
- Available in 6 sizes
- Available in over 70 designs

Dimensions





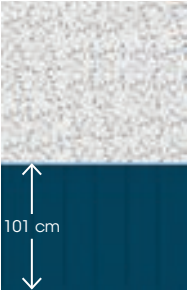
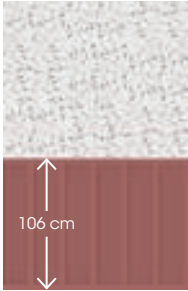
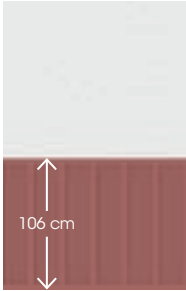
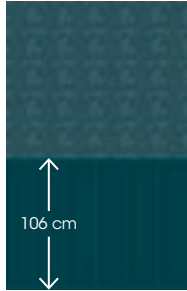
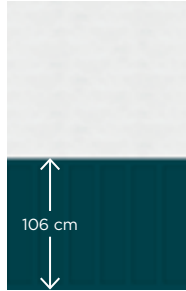

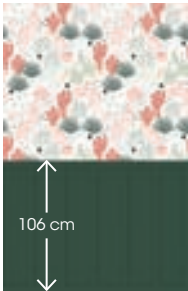



Designs chosen Mixed Green + Cactus with Sage Coating

Colours

 101 cm	 106 cm	 106 cm	 106 cm	 106 cm	 106 cm
Blue Cladding + Blue Terrazzo	Mixed Terracotta + Terracotta Terrazzo	Mixed Terracotta + White Scalloped Edge	Mixed Midnight Blue + Exotica Blue	Mixed Midnight Blue + White Coating	Mixed Midnight Blue + Grey Terrazzo
 106 cm	 106 cm				
Mixed Green + Grey Terrazzo	Mixed Green + Cactus				

Features

-  More than 70 designs
-  10 year warranty
-  Ease of installation
-  Minimal preparation needed
-  Easy maintenance
-  100% waterproof
-  Lightweight & durable
-  Easy to cut



Designs chosen Mixed Midnight Blue + Exotica Blue with Exotica Blue

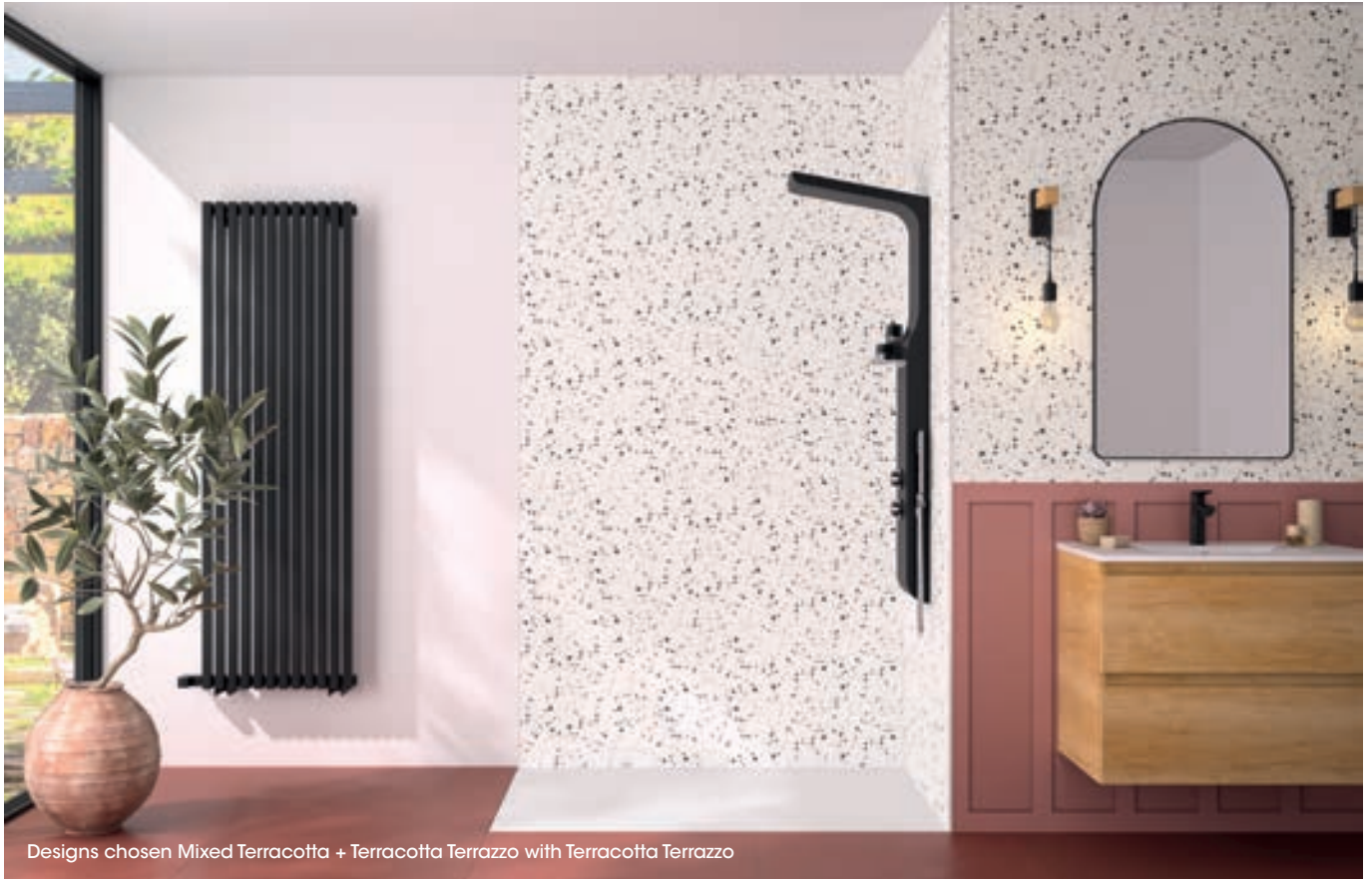

Designs chosen Mixed Terracotta + Terracotta Terrazzo with Terracotta Terrazzo



Design chosen Mixed Green + Grey Terrazzo



Designs chosen Mixed Midnight Blue + Grey Terrazzo with Grey Terrazzo

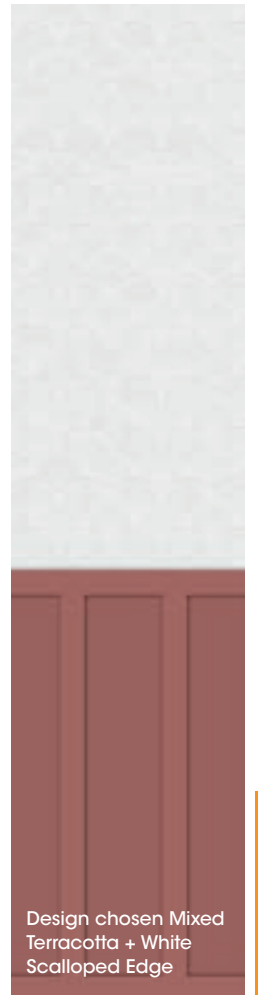

Minerals & Metals

Create the perfect New York loft look by mixing raw materials such as concrete and cement with mineral or metallic elements.

Add in the elegance of marble and a touch of gold or copper to the white, black and grey colour pallet and you can create this look.



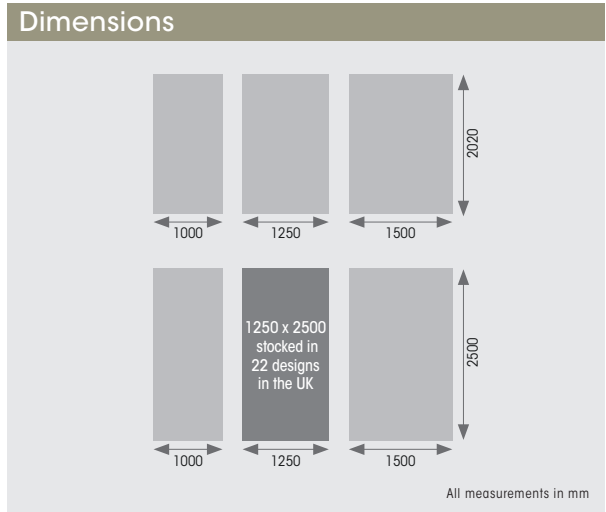



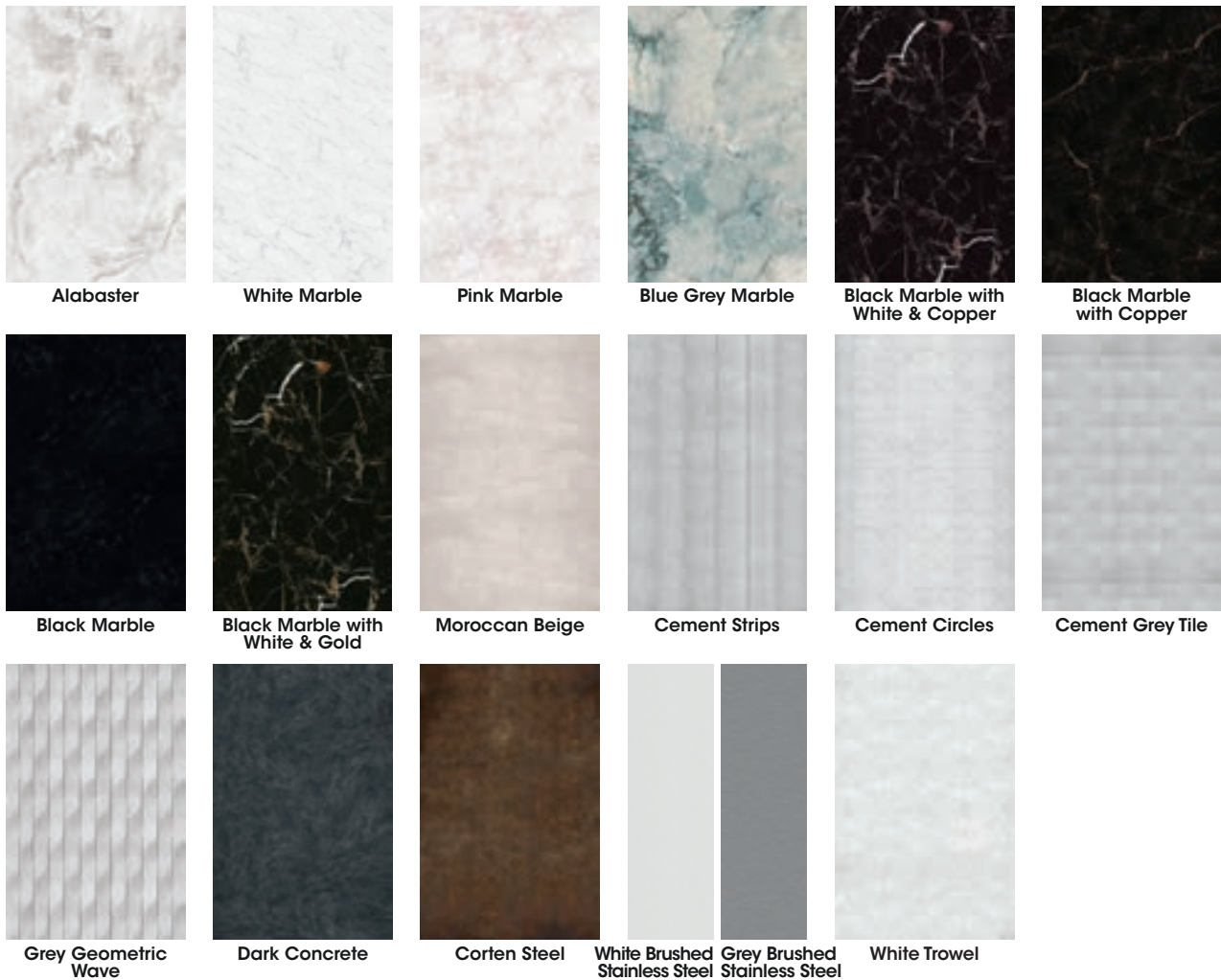

You can also add your own elements such as a splash of colour to this trend to create a bespoke designer loft look.



Colours



Features

- 
 More than 70 designs
- 
 10 year warranty
- 
 Ease of installation
- 
 Minimal preparation needed
- 
 Easy maintenance
- 
 100% waterproof
- 
 Lightweight & durable
- 
 Easy to cut



Designs chosen Black Marble Tile with Alabaster



Designs chosen Grey Geometric Wave with Stone Grey Coating



Designs chosen Black Marble with Pink Marble



Designs chosen White Marble with Black Marble with Copper



Design chosen Blue Grey Marble



Design chosen Black Marble with White & Gold



Design chosen Dark Concrete



Design chosen Corten Steel



Design chosen Grey Brushed Stainless Steel

Nature

Bringing the outdoors in creates a relaxing mood, but adding a bold print can make your bathroom feel like a spa experience every day!

Mixing bold pattern with natural woods and the natural colour palette you can create the perfect calming space or a bold exotic room depending on your taste.

Dimensions



Colours



Cactus



Desert Cactus



Palm Trees

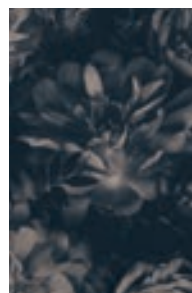

Floral



Banana Trees



Banana Trees Black & White



Jungle

Features



More than 70 designs



10 year warranty



Ease of installation



Minimal preparation needed



Easy maintenance



100% waterproof



Lightweight & durable



Easy to cut



Designs chosen Jungle



Designs chosen Banana Trees Black & White



Design chosen Floral



Designs chosen Grey Terrazzo with Palm Trees



Designs chosen Desert Cactus with Beige Coating



Designs chosen Exotica Green with Vertical Wood Design

Patterns & Geometric

The latest trends in patterns and geometric designs are available on our wall panels. Tiles, scalloped edge, hexagon, herringbone or even cement tiles, you can choose the design that suits your taste and personality. With different colours and bold patterns you can create a big impact in a small space or you can mix and match to create the perfect look for you.

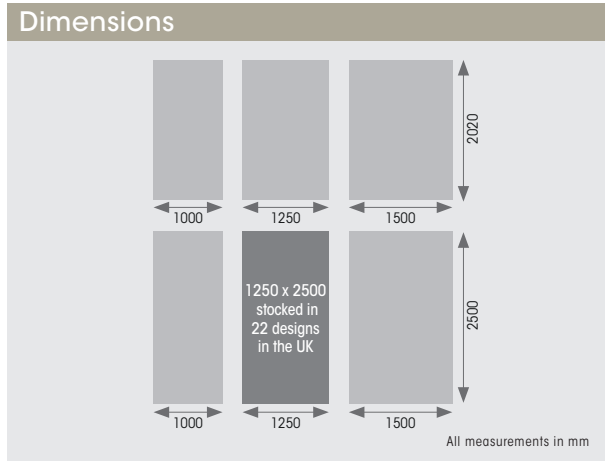

Colours

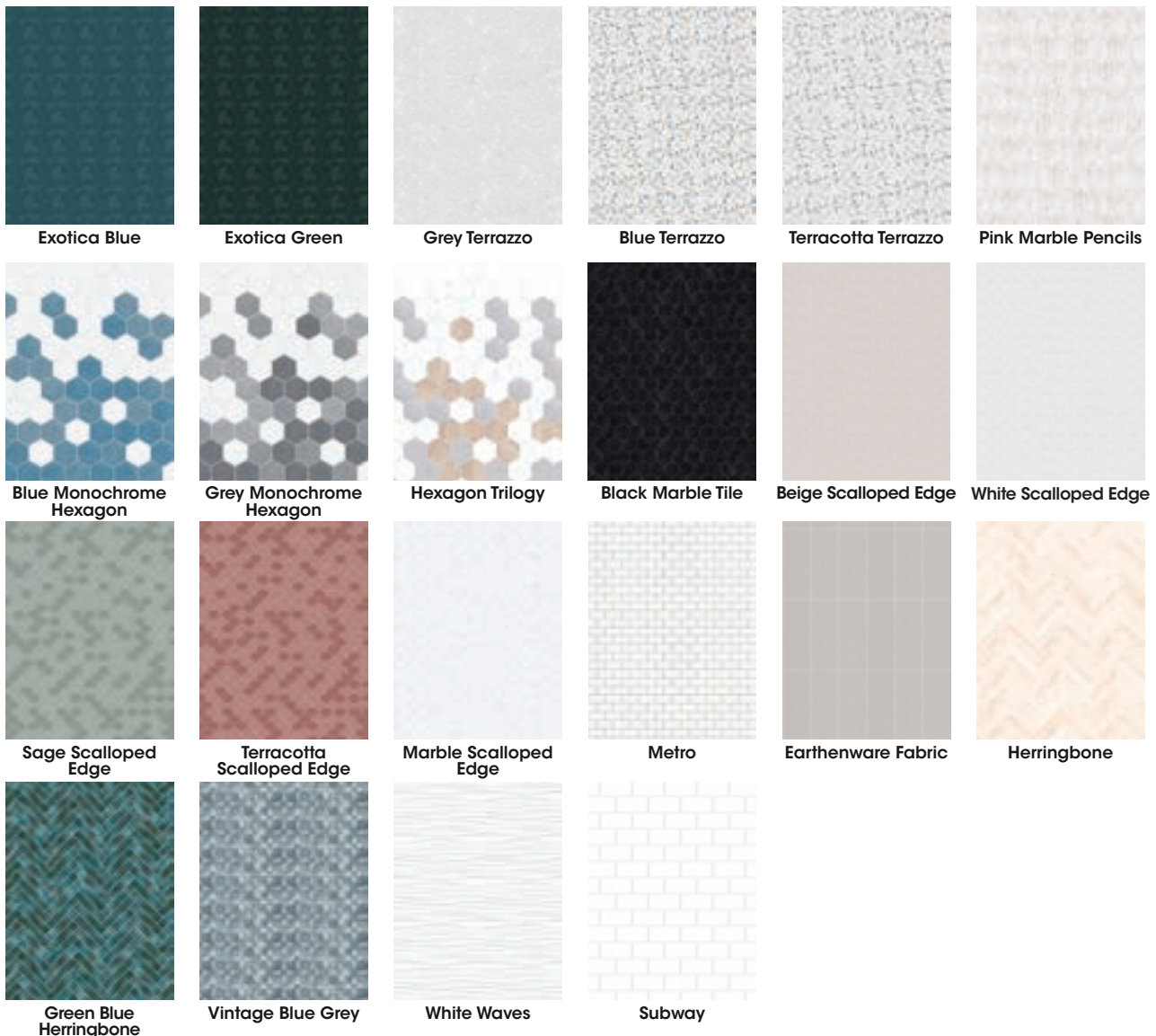

Features

- More than 70 designs
- 10 year warranty
- Ease of installation
- Minimal preparation needed
- Easy maintenance
- 100% waterproof
- Lightweight & durable
- Easy to cut



Designs chosen Beige Scalloped Edge with Terracotta Coating

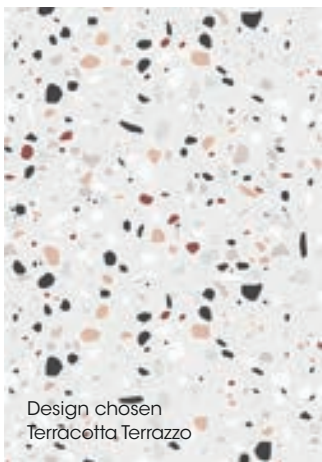



Design chosen Hexagon Trilogy



Designs chosen White Waves with Black Marble



Design chosen Metro



Designs chosen Green Blue Herringbone with Corten Steel

Wood

Whether you want to create the perfect Scandinavian look, a gorgeous seaside chalet or a quintessential English cottage, wood can help you to create the perfect look.

From classic wooden strips to modern graphic wood design or simple panelling, Kinewall has a variety of designs to choose from to help you create the theme you want in your bathroom.

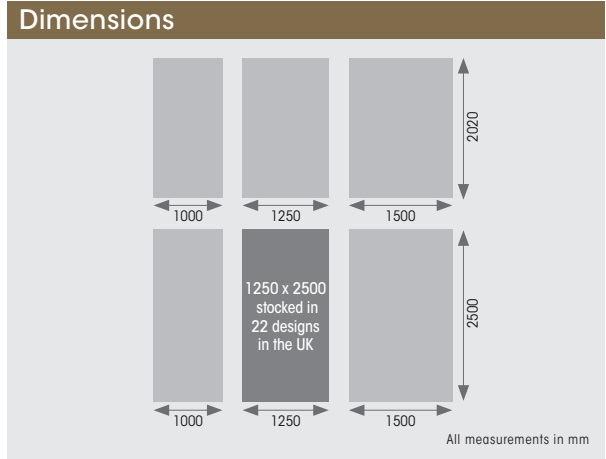

Colours



Features





Design chosen Beige Horizontal Panelling



Design chosen Celadon Green Vertical Panelling



Design chosen Horizontal Wood Design



Designs chosen Graphic Wood Design with Cement Strips



Design chosen White Cladding



Designs chosen Midnight Blue
Vertical Panelling with Blue Terrazzo



Design chosen Terracotta Horizontal Panelling



Design chosen Walnut



Designs chosen Jungle with Sage Coating



Designs chosen Cactus with Terracotta Horizontal Panelling

















Design chosen Herringbone



Designs chosen Vintage Blue Grey with Anthracite Grey Coating

Kinewall accessories

Profile	Sizes and Colours			Use	Pack size
	2500 or 2020mm height. For 2020mm, replace 250 with 202 in product code				
L shaped inside corner	Black  KINWALL250LNIG	Chrome  KINWALL250LAB	White  KINWALL250LB	Attach 2 Kinewall panels at a 90 degree closed angle.	1
L shaped outside corner	Black  KINWALL250LSNIG	Chrome  KINWALL250LSAB	White  KINWALL250LSB	Attach 2 Kinewall panels at a 270 degree open angle.	1
U shaped	Black  KINWALL250UNIG	Chrome  KINWALL250UAB	White  KINWALL250UB	Cover the ends of a panel.	2 (1 for each side)
H shaped	Black  KINWALL250HNIG	Chrome  KINWALL250HAB	White  KINWALL250HB	Attach 2 Kinewall panels side-by-side. Side-by-side installation possible without profile. Use magnets and metal strip instead (see below).	1
Magnet  KINWALLAIM01	Metal Strip  KINWALLBAND01			To attach 2 Kinewall panels side-by-side, without a H shaped profile. Metal Strip dimensions: 75 x 2510mm.	1 (Magnet and Metal Strip sold individually)

Your choice installation

With profiles



• Inside corner profile - L shaped



• Outside corner profile - L shaped



• U shaped profile for panel ends



• H shaped profile for mounting 2 panels together

Profile colours



Chrome



White



Black

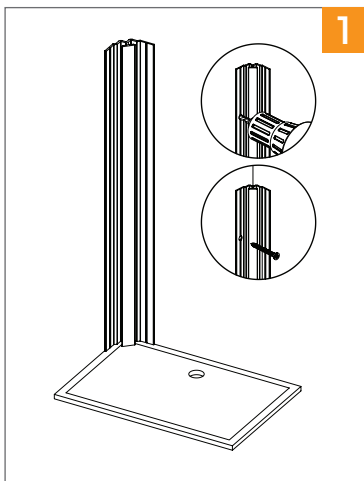

1

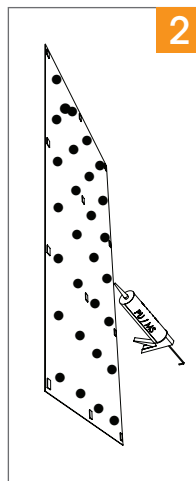

2

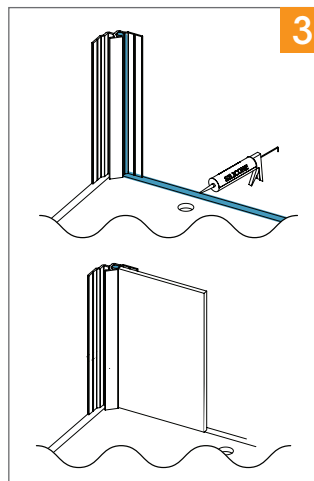

3

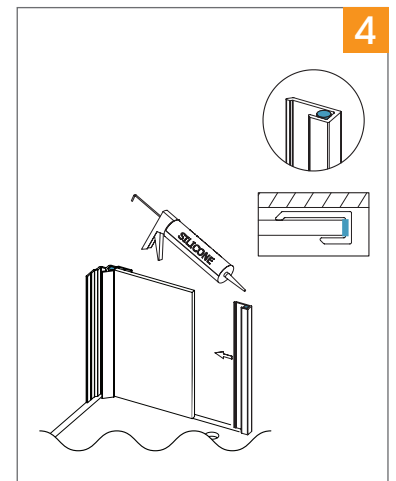

4

- 1 Screw the corner profile to the wall
- 2 Put the adhesive on the back of the panel then attach the PU or MS polymer glue pads
- 3 Silicone the inside of the corner profile as well as the edge of the tray then insert the panel which has already been cut or drilled to size as needed
- 4 Silicone the end profile then slide it onto the panel

Repeat steps 2 - 3 and 4 for the second side then finish with an end profile on the final panel

Without profiles



- Metal strip for mounting 2 panels together without profile
- Kit (magnet) for use with metal strip

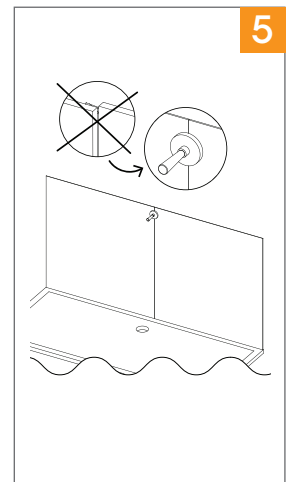
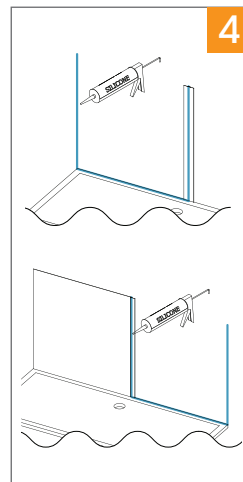
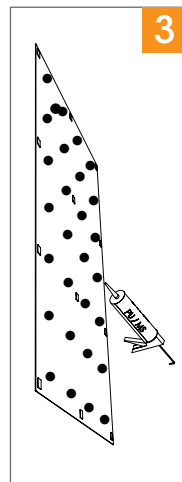
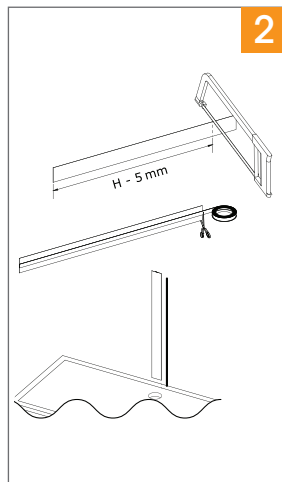
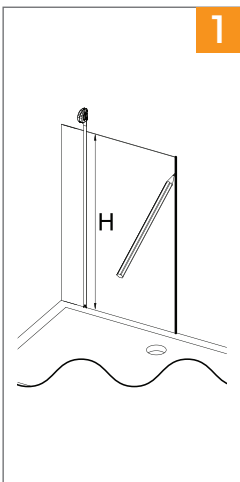

- 1 Present the panel, measure the total height and make a mark at the right end of the panel
- 2 Cut the metal strip, subtracting 5mm from the measurement made above. Position the adhesive on the back and stick the strip to the wall
- 3 Put the adhesive on the back of the panel then attach the PU or MS polymer glue pads
- 4 Silicone the corner of the wall, the middle of the metal strip as well as the edge of the tray then insert the panel which has already been cut or drilled as needed. Repeat for the second panel
- 5 Use the magnet to help align the panels perfectly

Profile can be used on the final panel to finish the look



For more information on each of our product ranges please see kinedo.co.uk

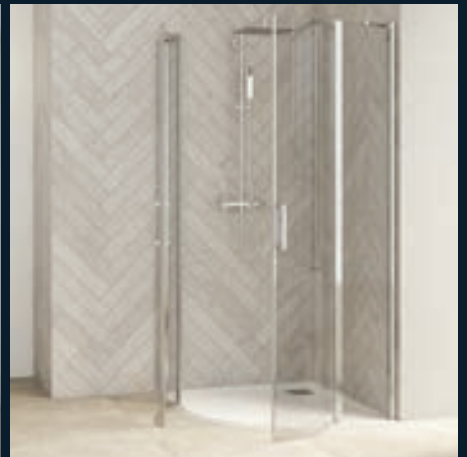
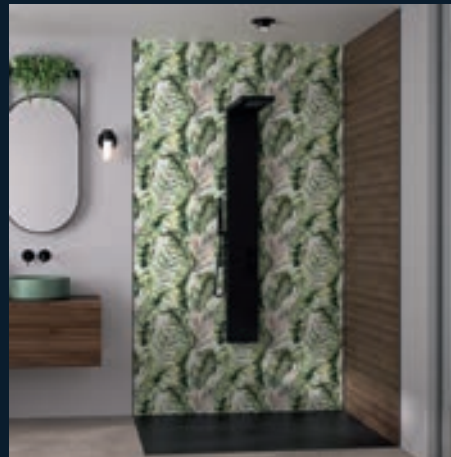
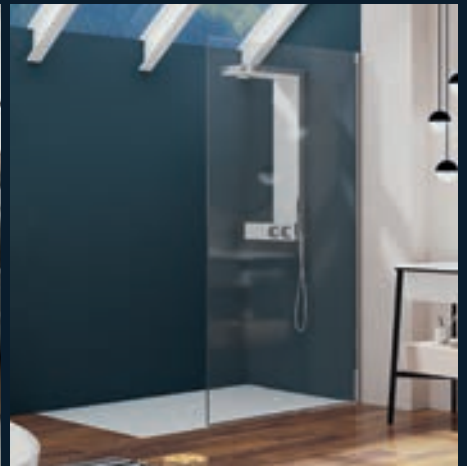



10 year
warranty

Our Kinedo range has a warranty of up to 10 years

Two years as standard with an additional
eight years on parts.

For full details see kinedo.co.uk

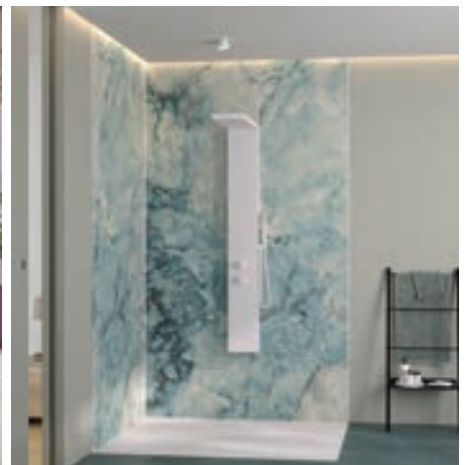
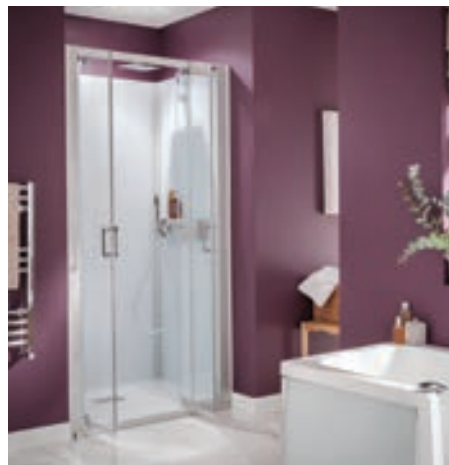

Kinedo



SFA Saniflo UK Ltd
Unit 1, Watford Interchange
Colonial Way
Watford
Herts WD24 4WP
United Kingdom

Tel 020 8842 0033
Web www.kinedo.co.uk

As our policy is one of continuous product improvement we reserve the right to alter product specification without notice. All information in this publication is given in good faith. No responsibility can be accepted for any errors, omissions or incorrect assumptions. 06/24. BROCH-0025.